

STOCK MOULDING CATALOG
WHITE BROTHERS MILL
OCTOBER 2022



WHITE BROTHERS MILL

MANUFACTURER OF MOULDINGS & MILLWORK
SERVING THE BAY AREA SINCE 1872

STOCK MOULDING CATALOG

www.WhiteBrothersMill.com

HISTORY

White Brothers since 1872 - "Where we came from and how we got here"

White Brothers has proudly served the Bay Area for over 145 years, with a history that has spanned several generations of one family and survived such events as the great 1906 San Francisco earthquake.

Formed in 1868, White Brothers began as the Straut-White Company, originally located in San Francisco at Sacramento and Davis Streets. In 1872, Peter White, one of the partners, was joined by his brother, Asa. Together they bought out Straut's interest and renamed the company White Brothers. Later, a third brother, Jacob joined the firm.

The following years were prosperous for White Brothers, and to keep pace with a growing business and an increasing inventory, the company expanded into larger and larger spaces. They moved their headquarters from their original location to Market and California, then to Main near the docks, then to Spear and Howard. It was at this location that disaster struck. On April 18, 1906, the San Francisco earthquake and fire all but leveled the city. Incredibly, the inventory at White Brothers was spared, leaving it the only company in San Francisco with a supply of hardwood lumber. In the spirit of helping to rebuild the city, White Brothers did not take advantage of the disaster by raising its prices.

In 1910, the company moved the Fifth and Brannan Streets where it stayed until 1948. Jacob's son, Charles Harry White, managed the company from 1920 to 1948, at which time the company moved across the Bay to Oakland. From there, C.H. White's sons, Don, Charles and their cousin, W.T. White, Jr., carried on the tradition of the founders.

Now, a fourth generation White, Don F. White, Jr, continues the proud 147-year-old tradition that is the White Brothers Hardwood Lumber Company also known as White Brothers Mill. Over the years, White Brothers has developed an excellent reputation for quality millwork and outstanding service.

It is the collective heartbeat of the company that prides itself on the quality and craftsmanship that goes into being the best.

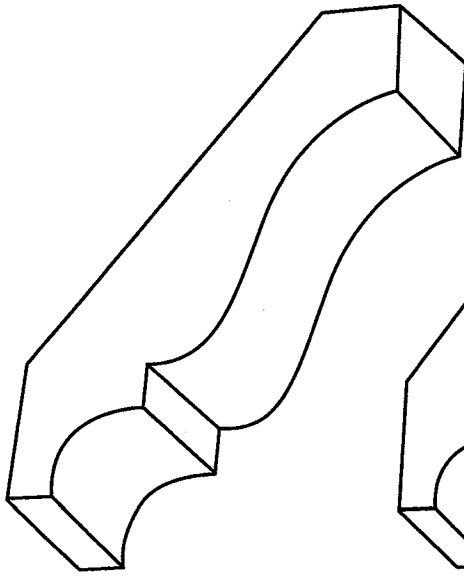

1103
5/8 x 3-1/4

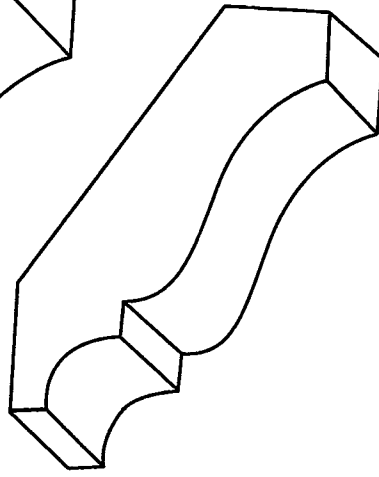

1102
5/8 x 2-5/8

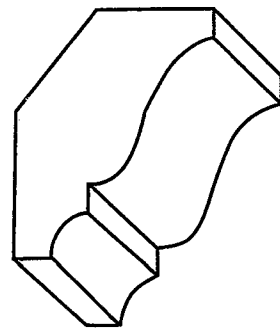

1101
5/8 x 1-5/8

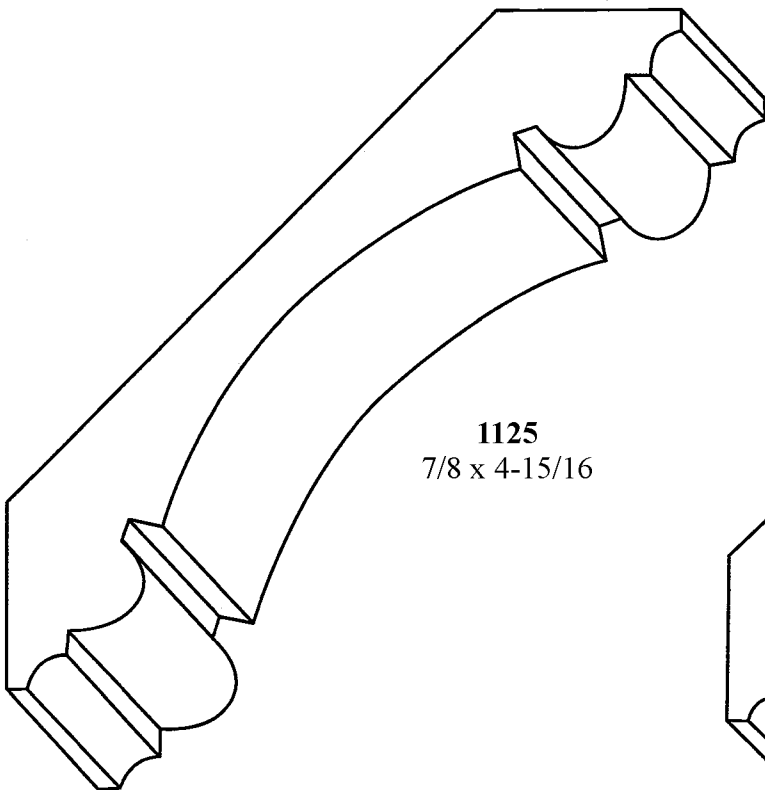

1125
7/8 x 4-15/16

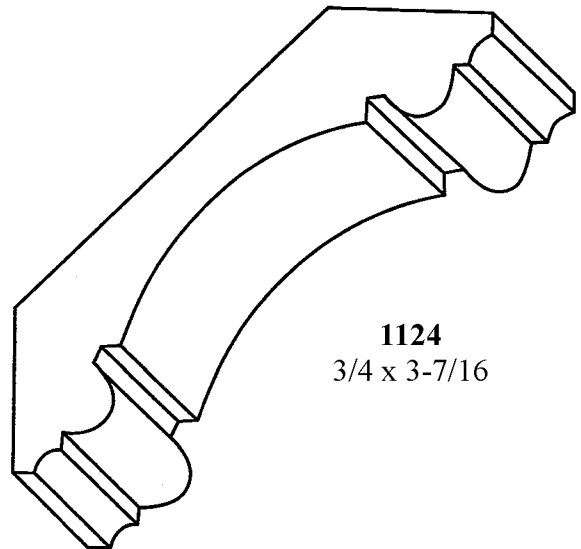

1124
3/4 x 3-7/16

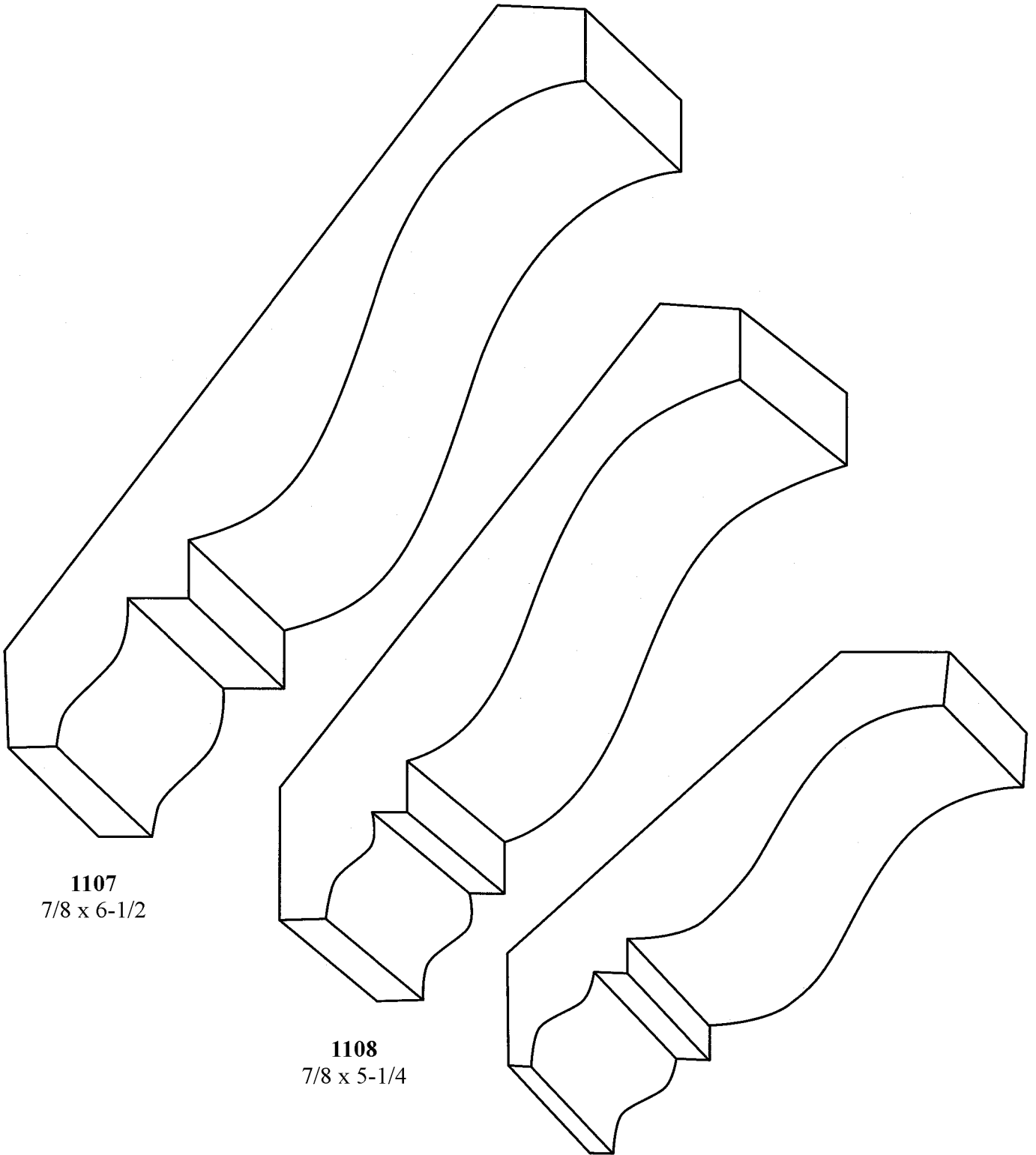

1107
7/8 x 6-1/2

1108
7/8 x 5-1/4

1116
3/4 x 4-1/8

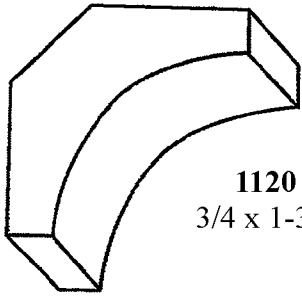

1120
3/4 x 1-3/4

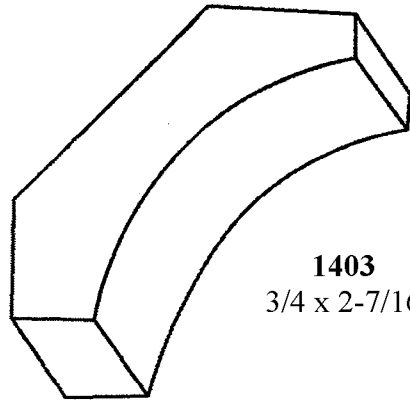

1403
3/4 x 2-7/16

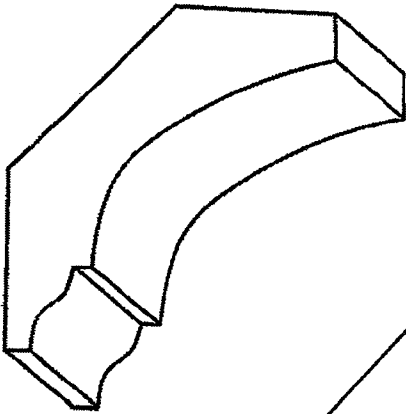

1404
3/4 x 2-1/2

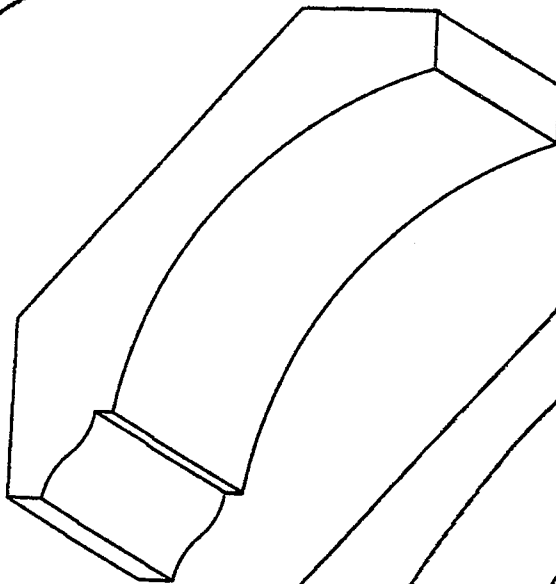

3-16
3/4 x 3-1/2

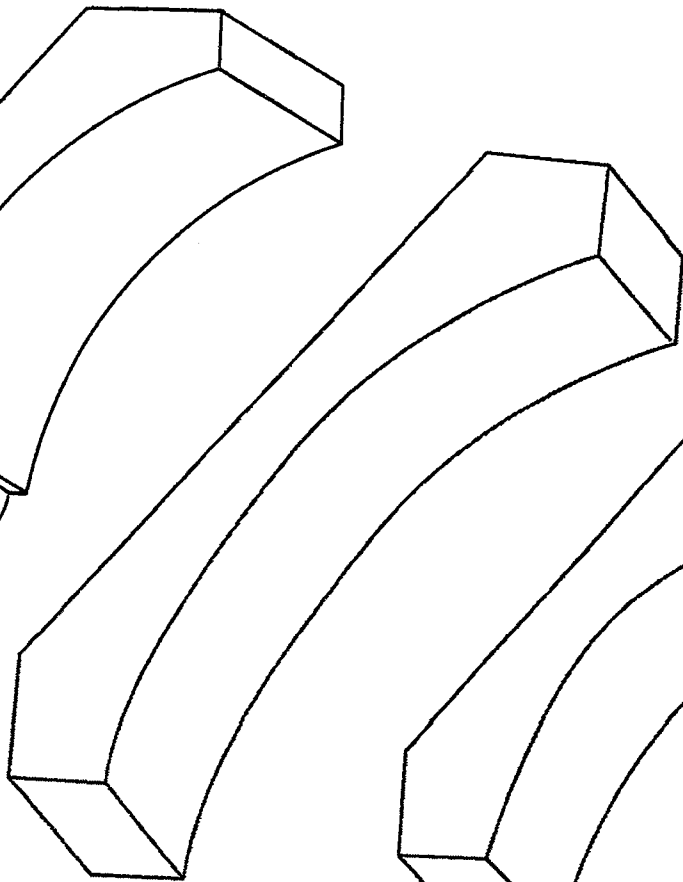

1122
13/16 x 4-1/2

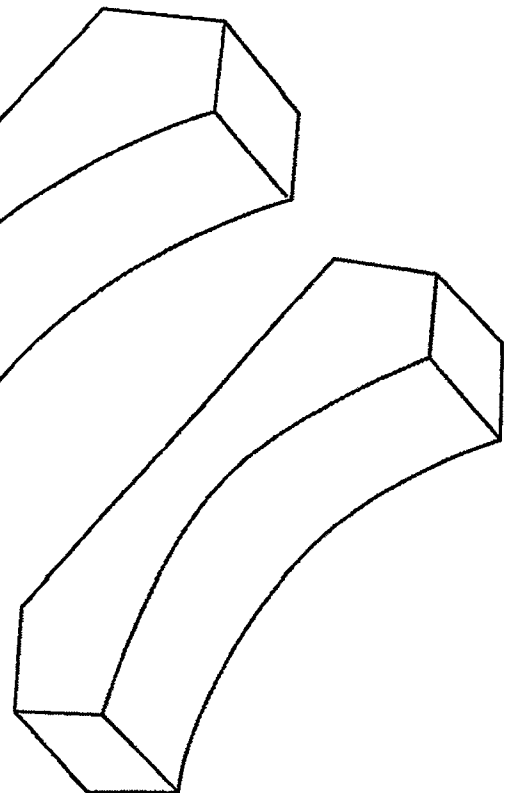

1121
11/16 x 3-3/16

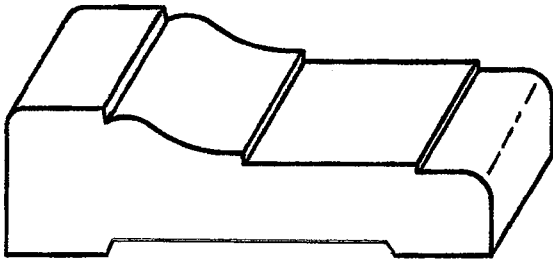

1255
3/4 x 2-1/2

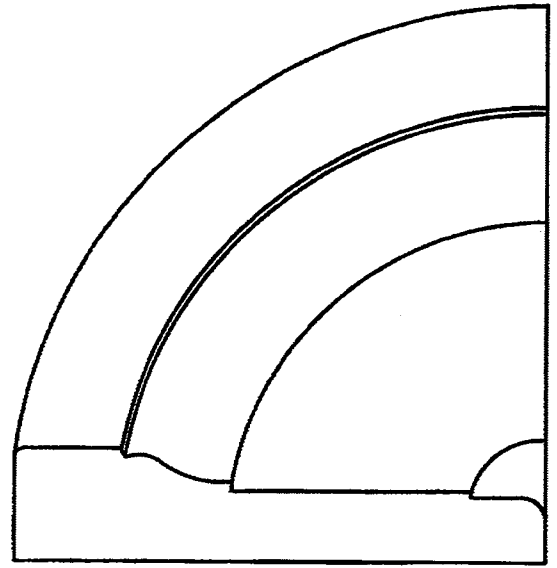

1256 CASING RADIUS CORNERS

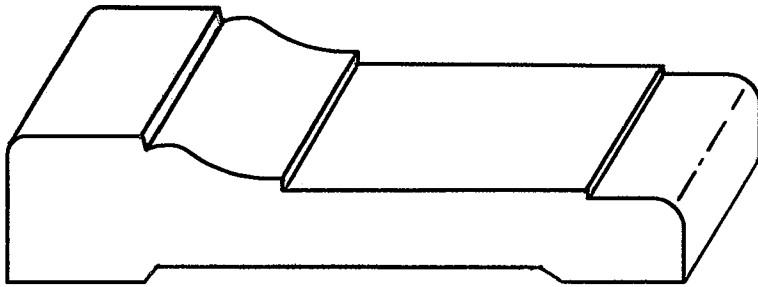

1256
3/4 x 3-1/2

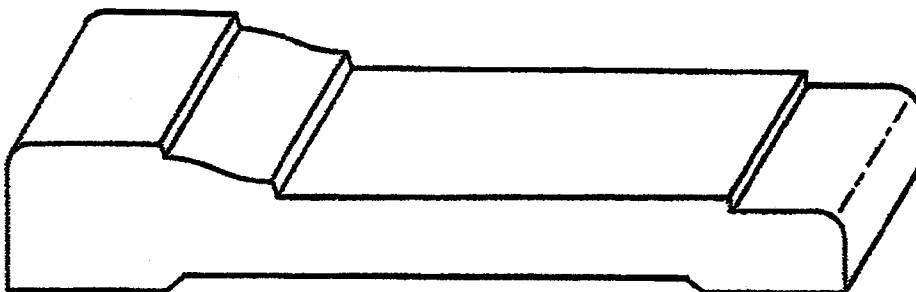

1254
3/4 x 4-7/16

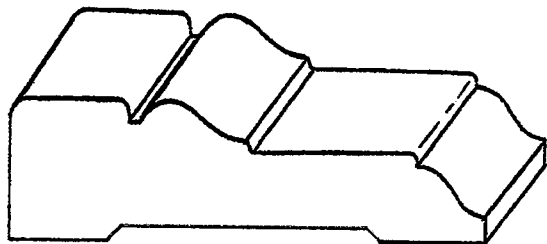

1216
3/4 x 2-1/2

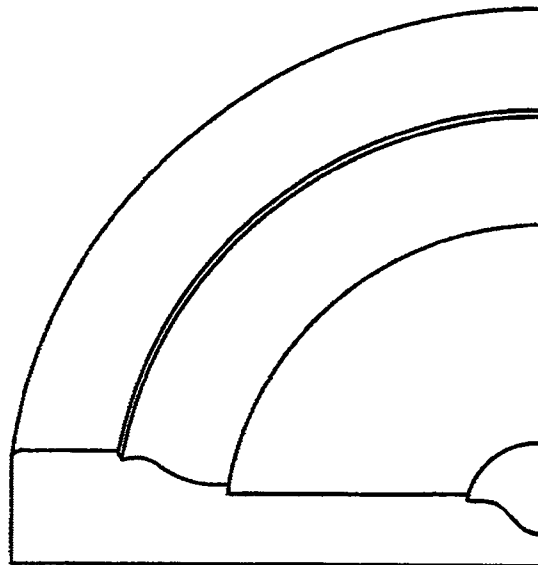

1210 CASING RADIUS CORNERS

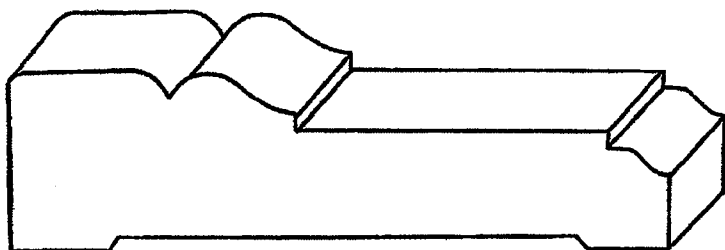

1210
7/8 x 3-7/16

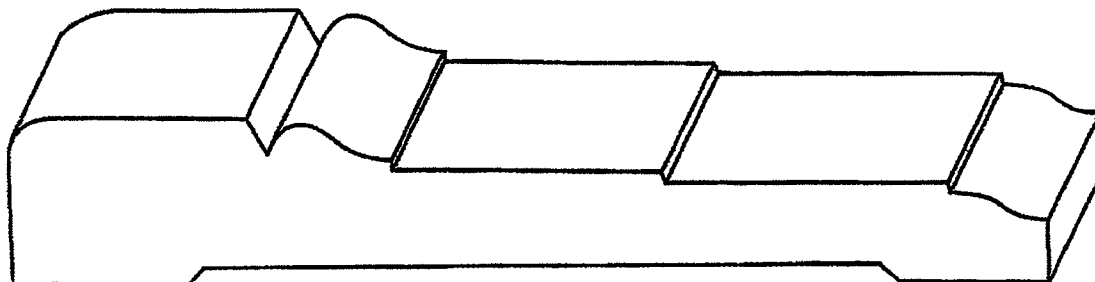

1211
7/8 x 5-7/16

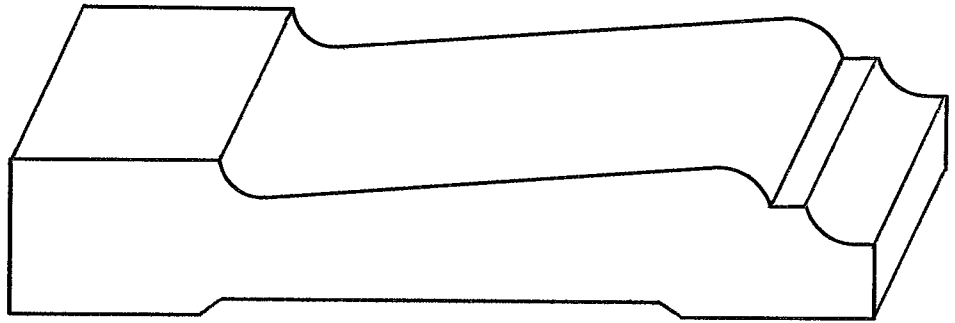

1214
13/16 x 4-1/2

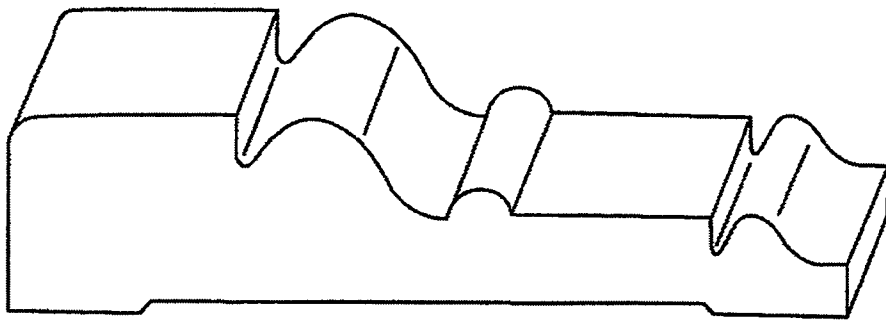

1222
1-1/16 x 4-7/16

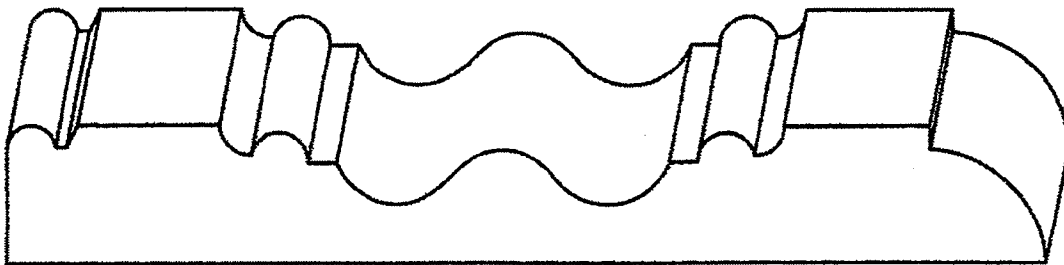

14-54
3/4 x 5-1/2

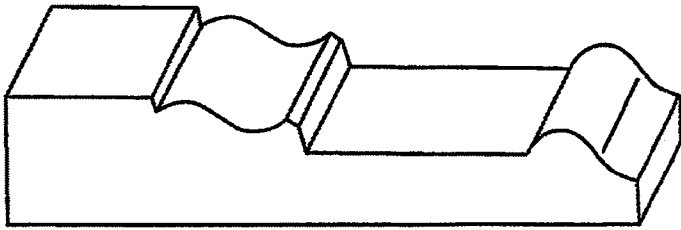

1244
11/16 x 3-5/16

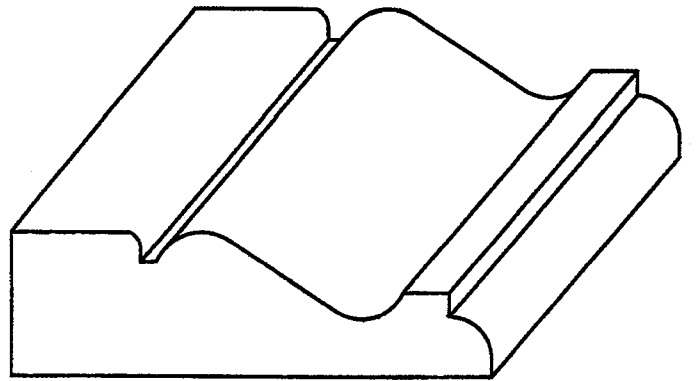

14-42
3/4 x 2-1/2

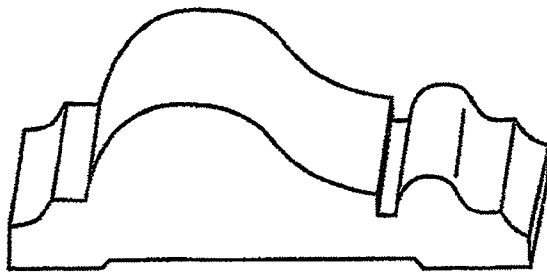

1233
7/8 x 2-3/4



1217
5/8 x 1-3/4

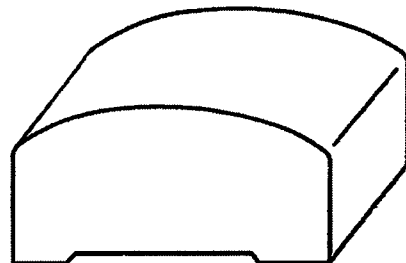

1218
13/16 x 1-11/16

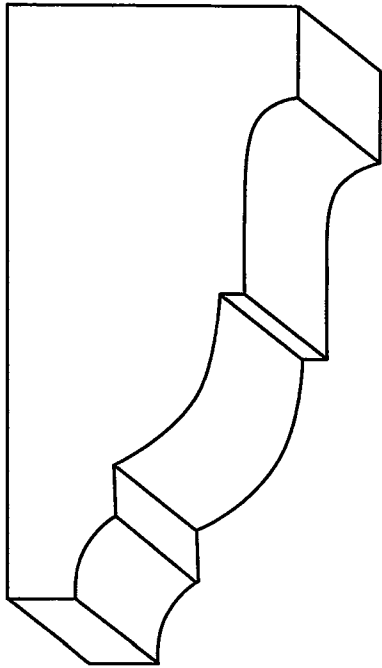

1242
1-1/2 x 3-1/16

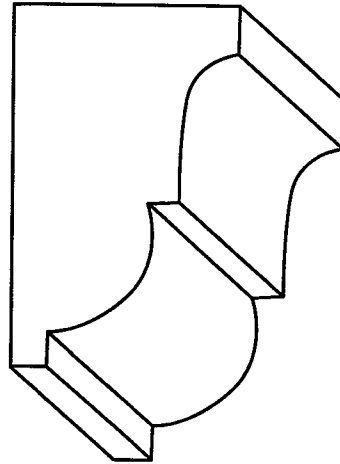

1930
1-1/8 x 1-7/8

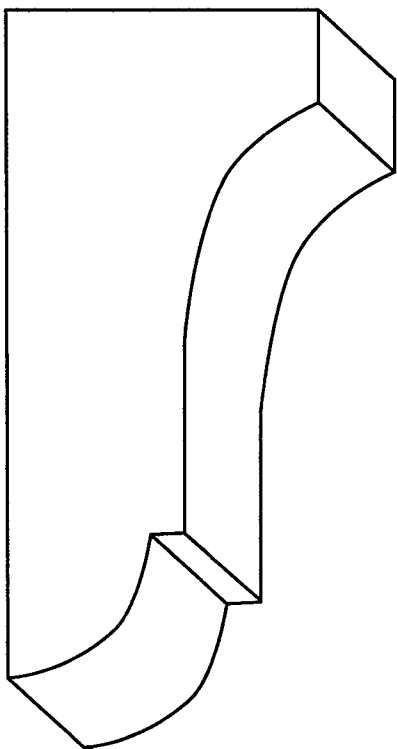

1243
1-5/8 x 3-7/16

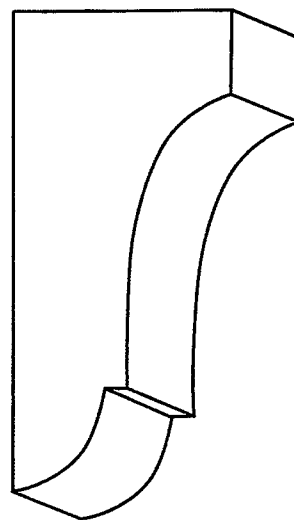

1263
1-1/8 x 2-1/2

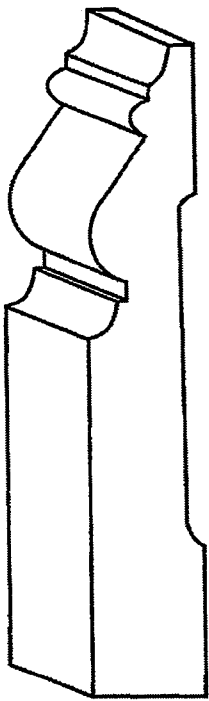

1334
9/16 x 3-7/16

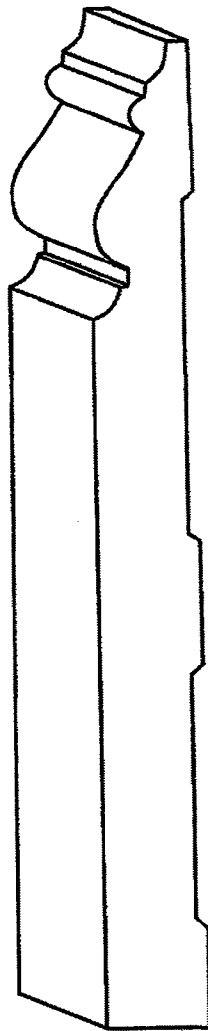

1336
9/16 x 5-1/4

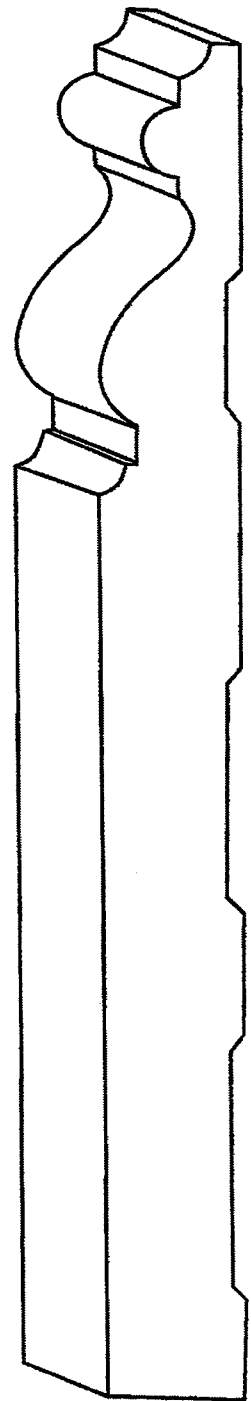

1338
11/16 x 7-3/16

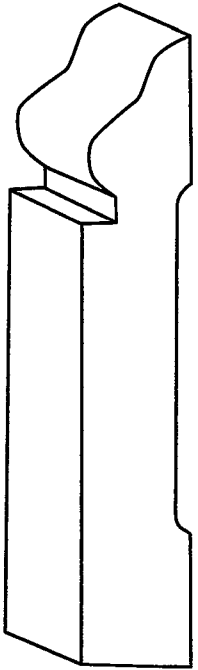

1308
9/16 x 3-1/4

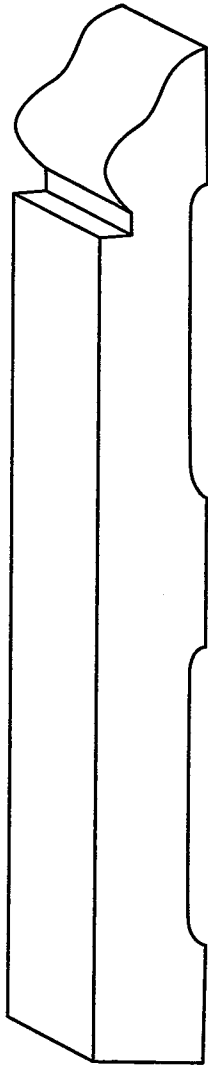

1310
9/16 x 5-1/4

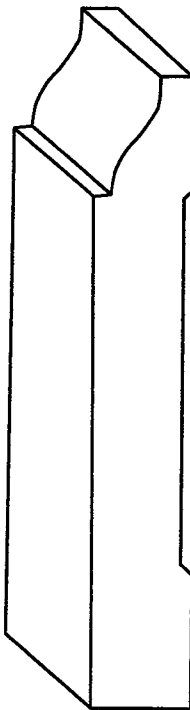

1304
9/16 x 3-1/4

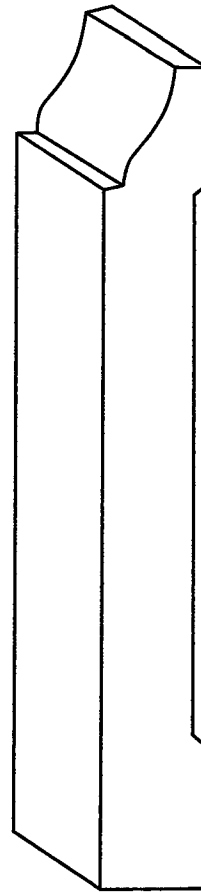

1305
9/16 x 4-1/4

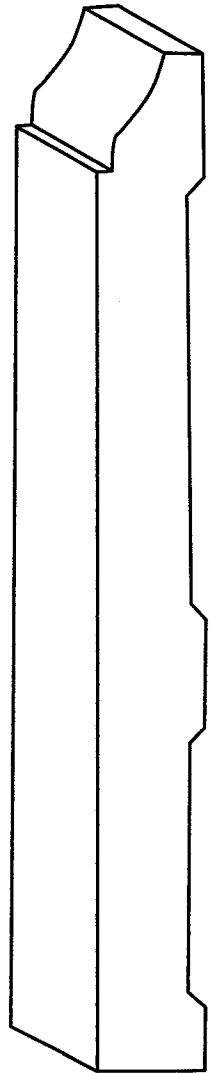

1306
9/16 x 5-1/4

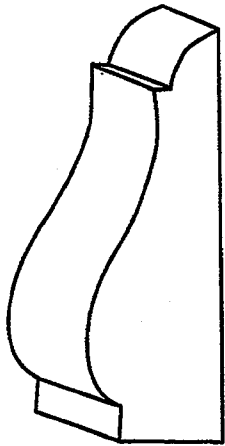

1365
11/16 x 2-1/8

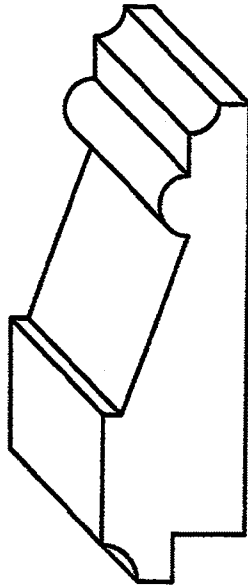

22-11
3/4 x 2-1/2

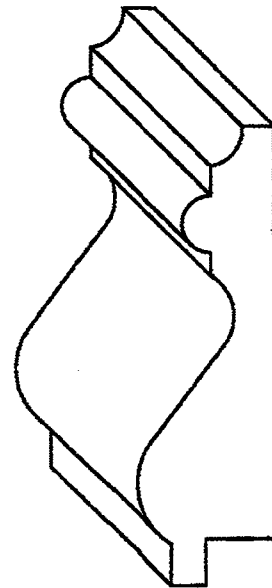

22-8
3/4 x 2-1/2

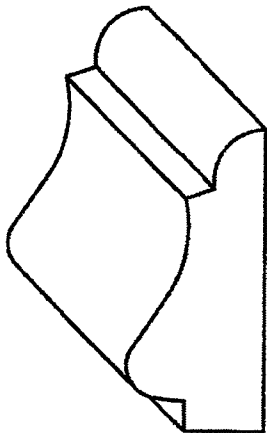

1-16
3/4 x 1-5/8

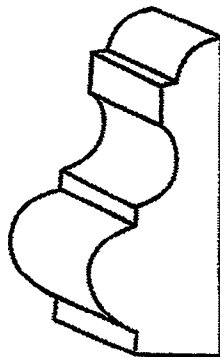

1352
3/4 x 1-11/16

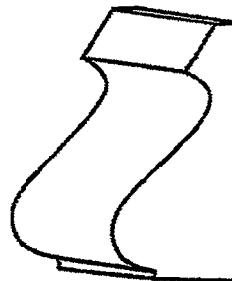

1351
11/16 x 1-3/8

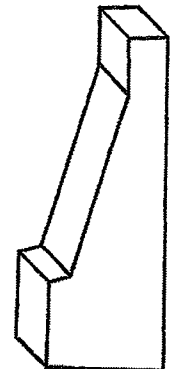

2125
5/8 x 1-3/4

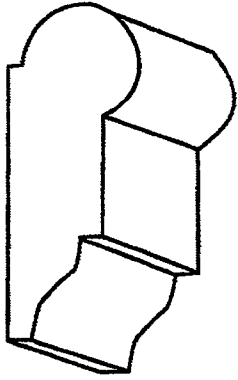

1620
11/16 x 1-3/4

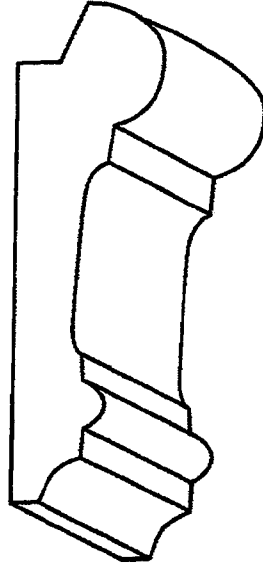

1621
11/16 x 2-5/8

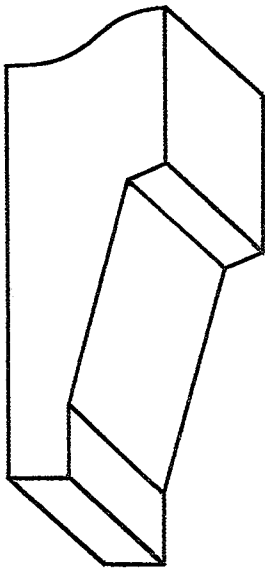

1623
13/16 x 2-7/16

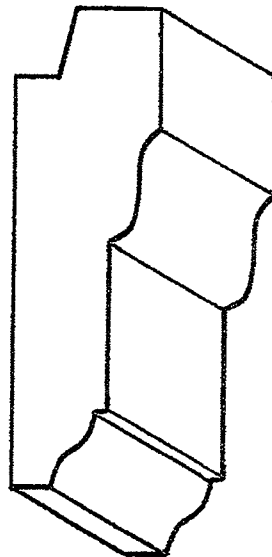

32-8
3/4 x 2-1/2

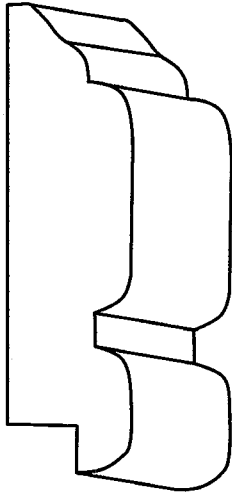

1607
5/8 x 2-7/16

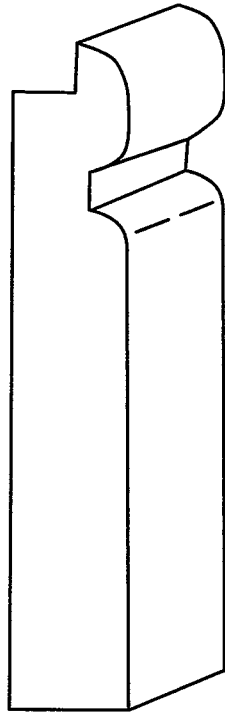

1629
5/8 x 3-7/16

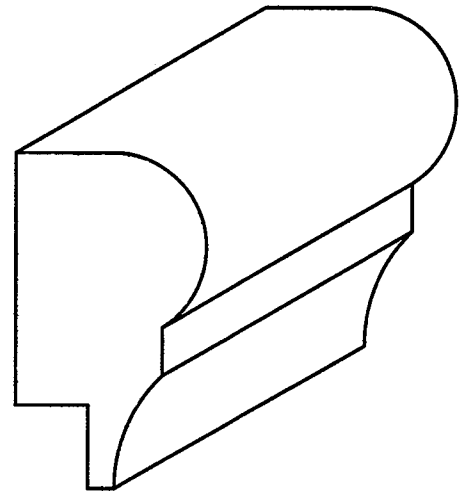

31-6
1 x 1-3/4

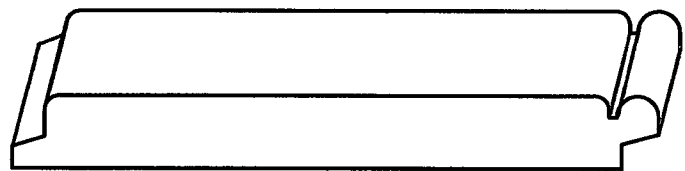

29-3
3/8 x 3-3/8

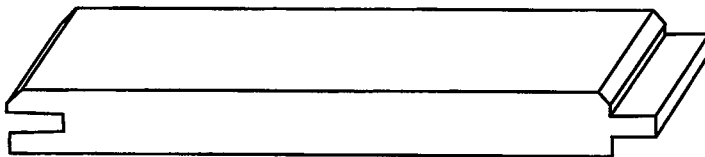

1600
11/32 x 3-3/8

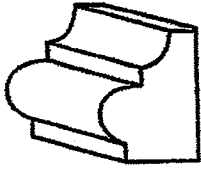

1700
9/16 x 3/4

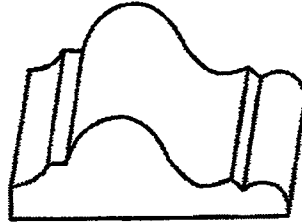

1703
9/16 x 1-1/2

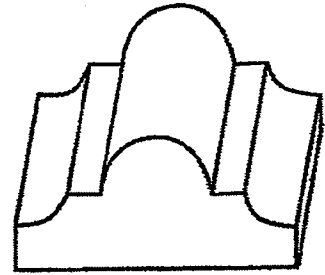

1704
11/16 x 1-1/2

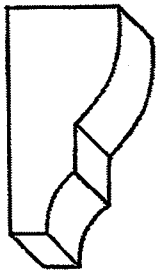

1415
5/8 x 1-1/4

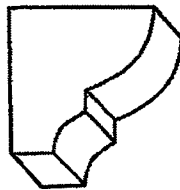

1405
3/4 x 3/4

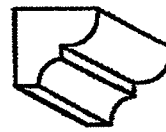

2901
7/16 x 7/16

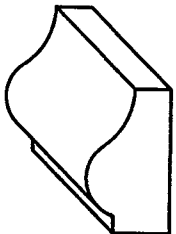

1-12
7/16 x 3/4

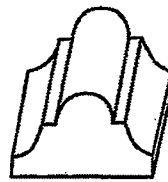

1706
7/16 x 3/4



2900
3/8 x 3/4

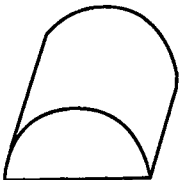

1905
3/8 x 3/4

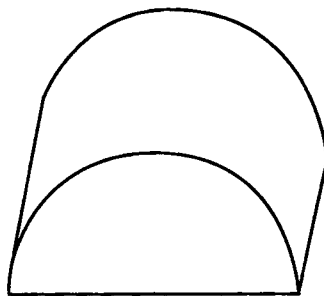

1907
3/4 x 1-1/2

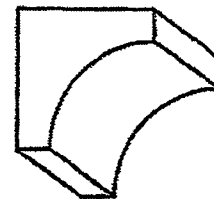

1401
3/4 x 3/4



1400
1/2 x 1/2

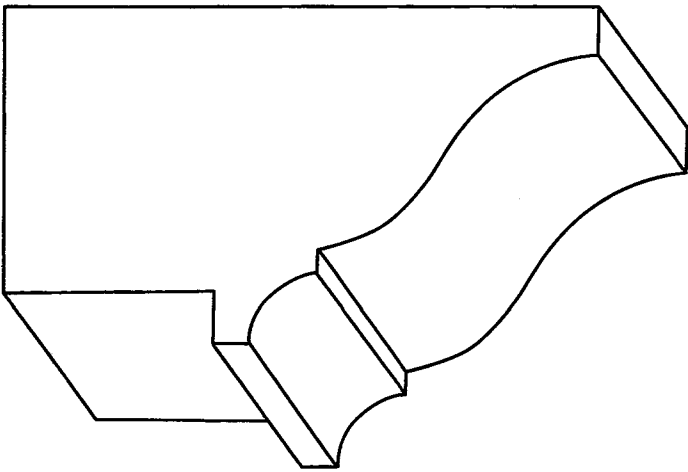

1921
1-3/4 x 3-1/16

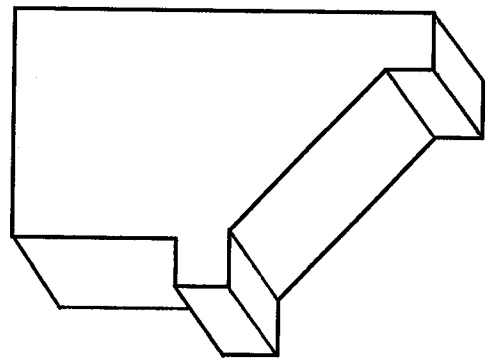

2120
1-7/16 x 2-3/16

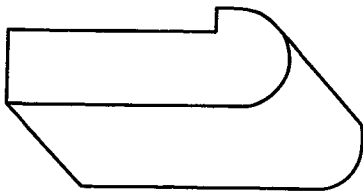

1923
1/2 x 1-7/16

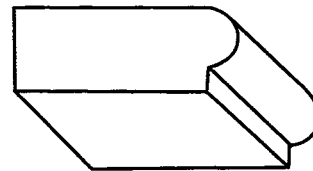

1917
7/16 x 1-1/8

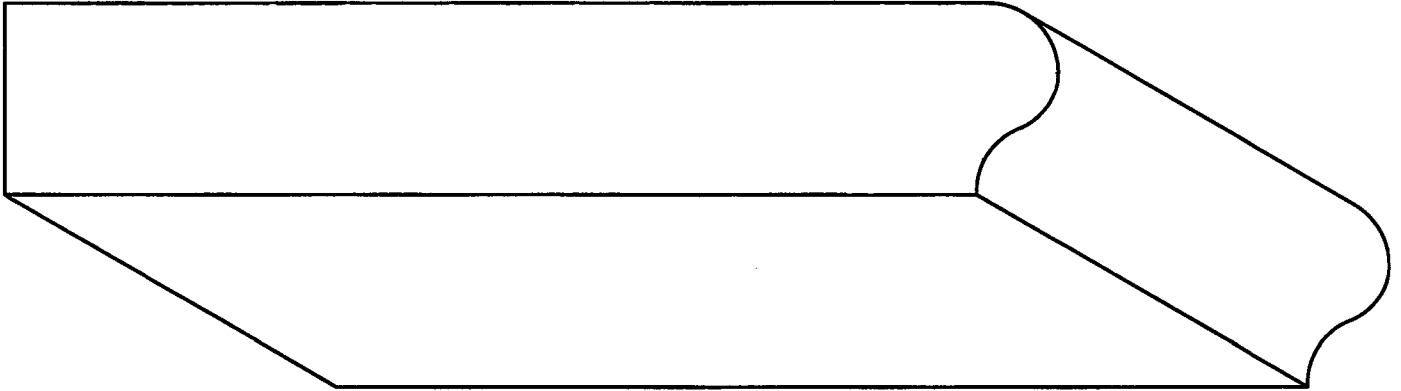

55-14
1 x 5-1/2

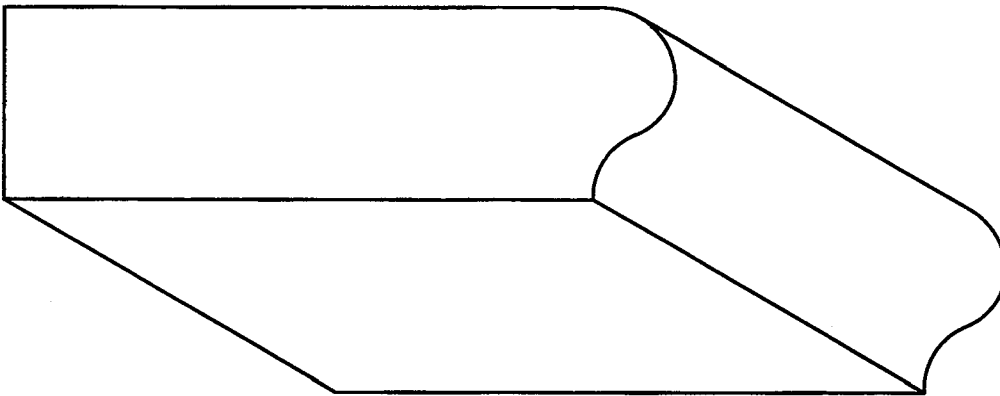

55-13
1 x 3-1/2

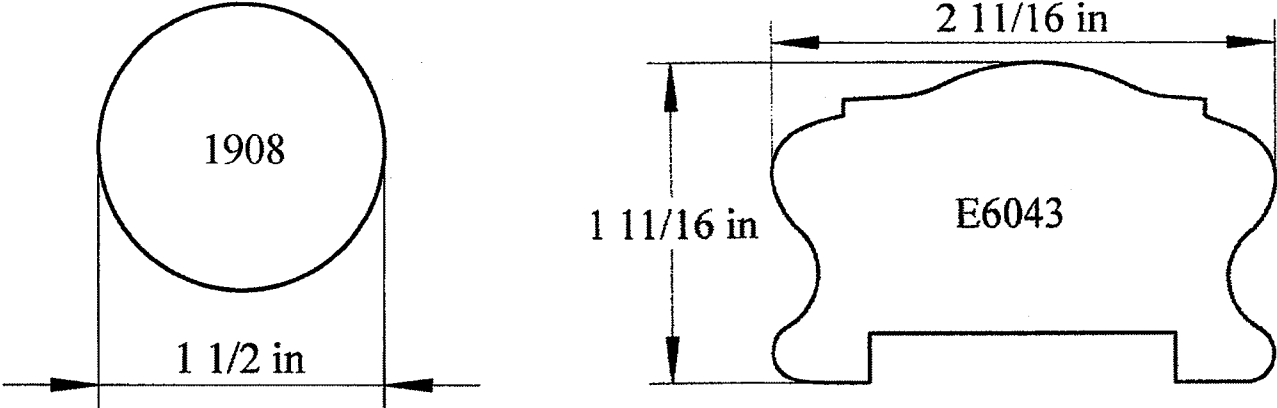

90 Degree Return Fitting for 1908 Hand Rail

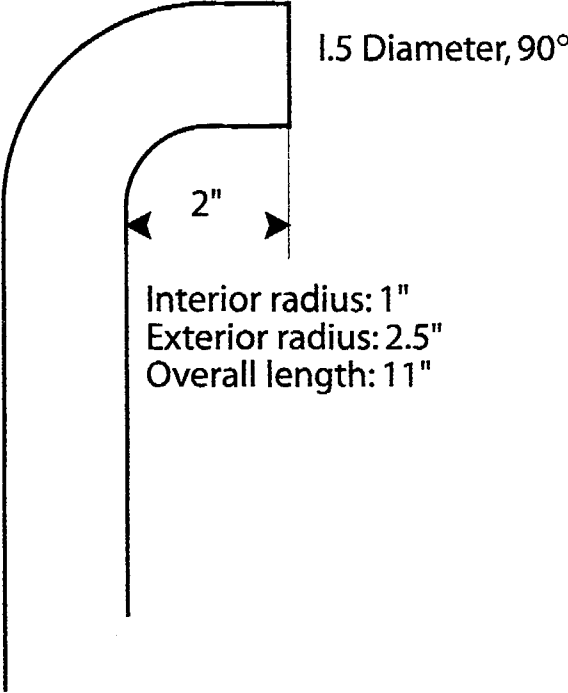

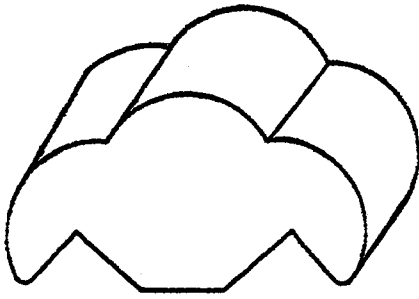

E-2127
1 x 1-7/8

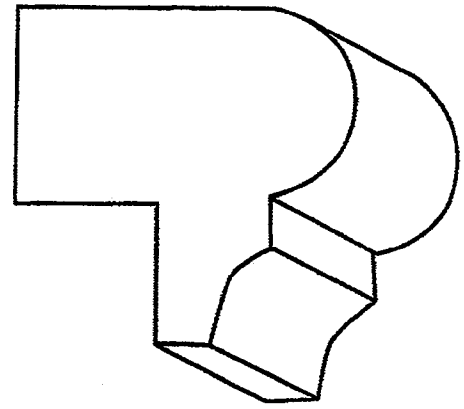

E-1609
1-3/4 x 1-3/4
3/4" RAB

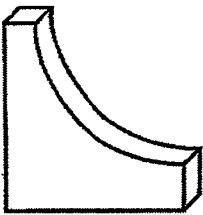

E-2121
1 x 1

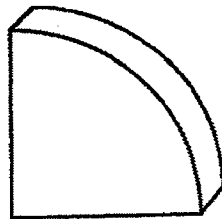

E-2122
1 x 1

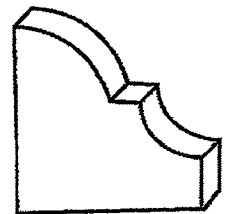

E-2123
1 x 1

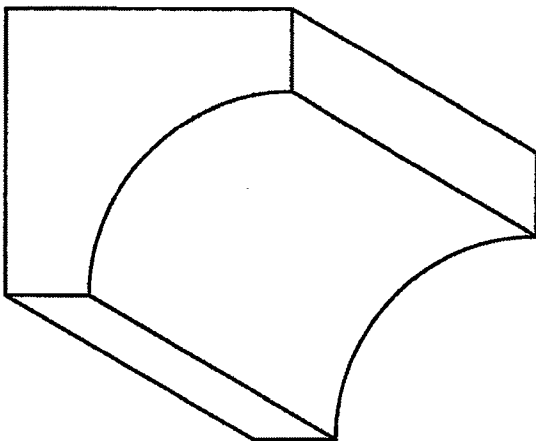

3-13
1-1/2 x 1-1/2

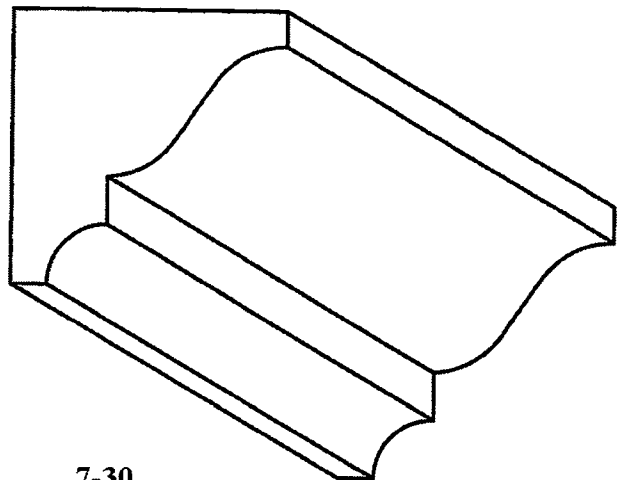

7-30
1-7/16 x 1-7/16

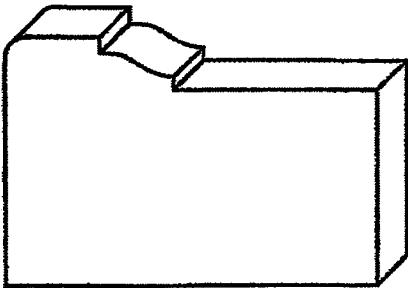

E-2106
1-5/16 x 2

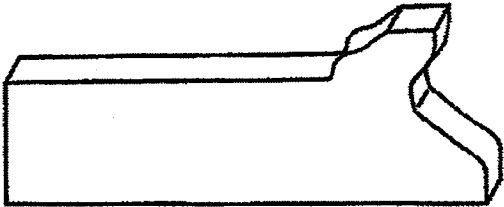

E-2111
15/16 x 2-5/8



E-2124
5/8 x 1-1/4

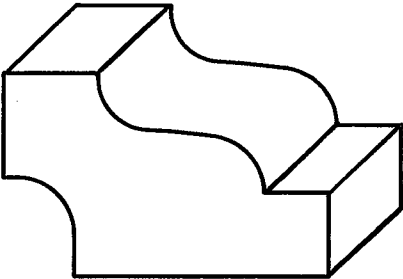

E-2110
1-1/16 x 1-11/16

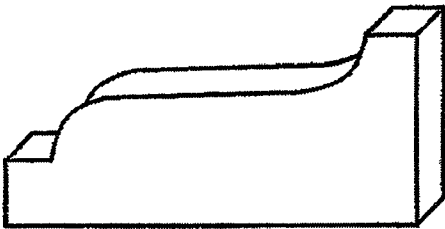

E-2115
1 x 2-1/4

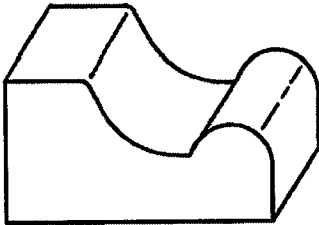

E-2128
3/4 x 1-3/8

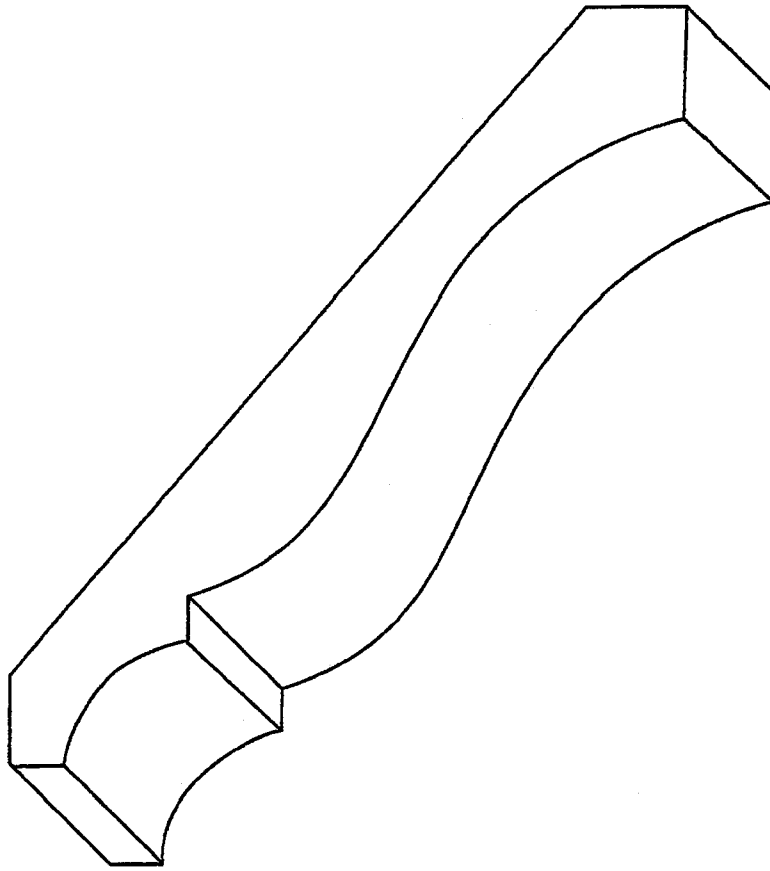

1105

11/16 x 5-1/4

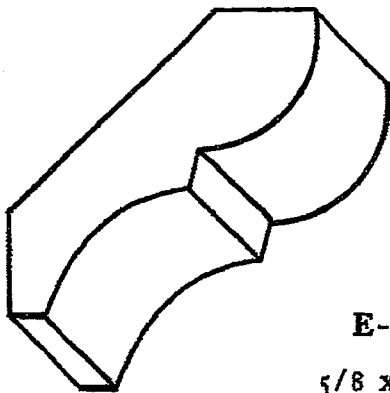

E-2119

5/8 x 2-1/4

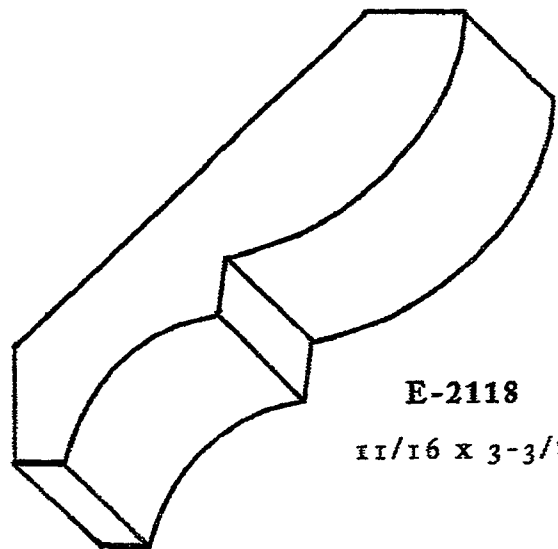

E-2118

11/16 x 3-3/8