

# SECTION 1- MOULDING CATALOG

WHITE BROTHERS MILL - CLASSIC MOULDING CATALOG

MOULDING PROFILES USED IN THE SAN FRANCISCO BAY AREA



## WHITE BROTHERS MILL

MANUFACTURER OF MOULDINGS & MILLWORK  
SERVING THE BAY AREA SINCE 1872

## 2022 CATALOG

[www.WhiteBrothersMill.com](http://www.WhiteBrothersMill.com)

# CATALOG INDEX

MLDG	PAGE #	MLDG	PAGE #	MLDG	PAGE #	MLDG	PAGE #	MLDG	PAGE #	MLDG	PAGE #
1100	3	1151	20	1247	34	1351	46	1602	54	1911-1912	48
1101	3	1152	19	1248	31	1352	46	1603	52	1913-1914	60
1102	3	1156	21	1249	31	1353	46	1604	52	1915	62
1103	3	1157	21	1250	30	1354	46	1605	52	1916	64
1104	3	1158	21	1251	30	1355	45	1606	52	1917	64
1105	4	1202	22	1254	33	1356	45	1607	53	1918-1920	61
1106	5	1203	22	1255	33	1357	45	1608	57	1921	65
1107	6	1204	22	1256	33	1358	45	1609	57	1922-3922	66
1108	6	1205	22	1257	30	1359	42	1610	57	1923	64
1109	5	1206	22	1258	30	1360	42	1614	52	1924	55
1110	7	2206	22	1259	30	1361	44	1615	54	1925	62
1111	5	1207	23	1260	32	1361	44	1616	54	1926	65
1112	7	1208	23	1261	32	1362	44	1617	52	1927	64
1113	7	1209	23	1262	32	1363	44	1618	54	1928-1929	65
1114	8	1210	23	1263	35	1364	44	1619	53	1930-1931	64
1115	8	1211	23	1264	35	1365	46	1620	53	1965	63
1116	6	1212	23	1265	33	1366	46	1621	53	1967	63
1117	9	1212	24	1267	31	1367	46	1622	51	1968	63
1118	9	1213	24	1268	31	1368	46	1623	53	2000-2003	56
1119	9	1219	25	1300	37	1369	46	1626	54	2102	3
1120	10	1220	24	1301	37	1400	47	1627	54	5116	16
1121	10	1221	24	1302	37	1401	47	1628	54	5119	16
1122	10	1222	24	1303	37	1402	47	1629	53	234	36
1123	10	1226	25	1304	37	1403	10	1630	51	162	36
1124	11	1227	25	1305	37	1404	47	1631	51	163	36
1125	11	1228	25	1306	37	1405	47	1700	55	164	36
1126	11	1229	25	1307	37	1406	48	1702	55	165	36
1127	12	1230	26	1308	38	1407	48	1703	55		
1128	12	1231	26	1309	38	1408	48	1704	55		
1129	12	1232	26	1310	38	1409	47	1705	55		
1130	13	1233	27	1311	38	1410	47	1706	55		
1131	13	2233	28	1312	39	1411	47	1707	55		
1132	13	1234	27	1313	42	1412	48	1708	55		
1133	13	2234	28	1314	42	1415	47	1711	56		
1134	4	1235	27	1315	40	1500	49	1712	56		
1135	14	2235	28	1316	40	1501	49	1713	56		
1136	14	1236	29	1317	40	1502	49	1714-1715	56		
1137	14	1237	29	1318	40	1503	49	1716	55		
1138	15	1238	29	1334	41	1505	49	1800	57		
1139	17	1239	29	1335	41	1506	49	1801	57		
1140	17	1240	34	1336	41	1507	49	1811-1812	58		
1141	17	1241	34	1338	39	1510	50				
1142	18	1242	35	1340	43	1511	50				
1143	18	1243	35	1341	43	1512	50	1820-1824	59		
1144	18	1244	34	1342	43	1513	50	1900	55		
1145	18	1245	34	1343	43	1600	51	1901-1909	60		
1150	19	1246	34	1350	46	1601	51	1910	55		

**NEW PROFILES ADDED**

1416	47
1611	57

**EXTERIOR MOULDINGS  
PGS 67-69**

**HANDRAIL PROFILES  
PGS 70-71**



CROWNS

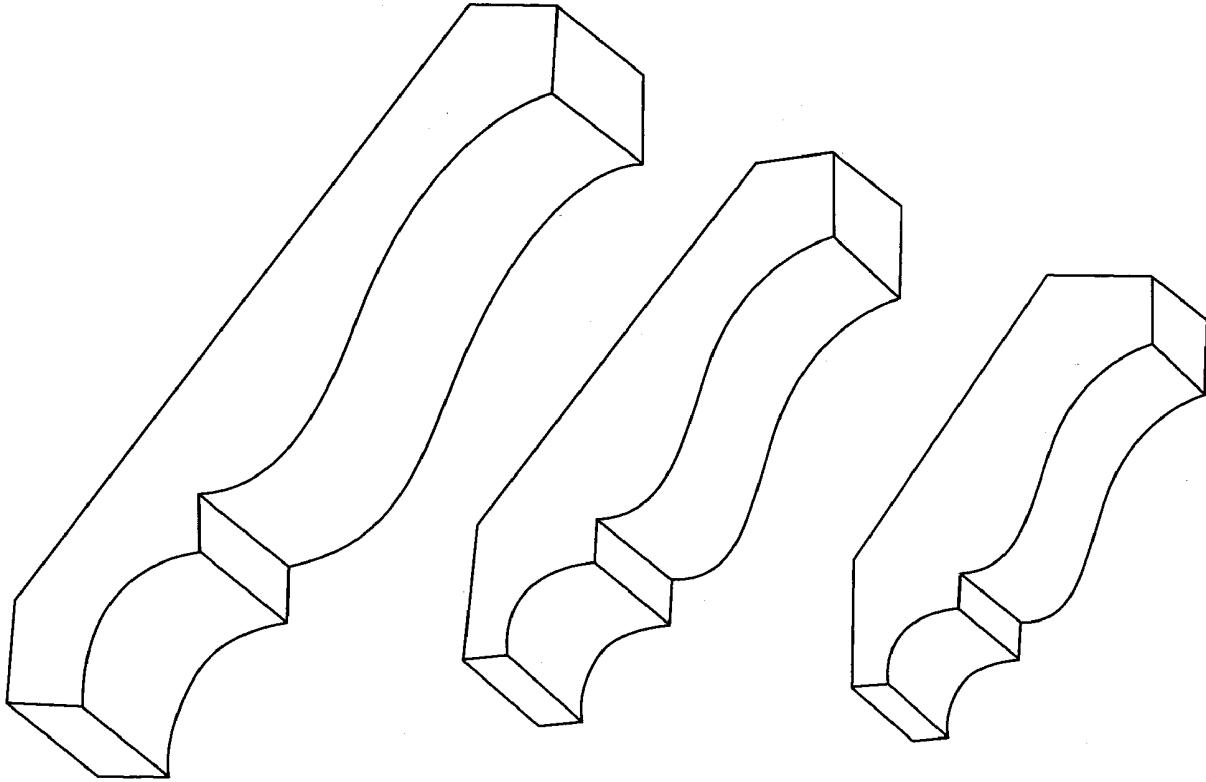

**1104**

$5/8 \times 4-5/8$

**1103**

$5/8 \times 3-1/4$

**1102**

$5/8 \times 2-5/8$

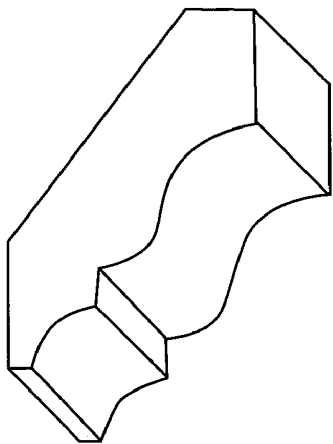

**2102**

$5/8 \times 2-1/4$

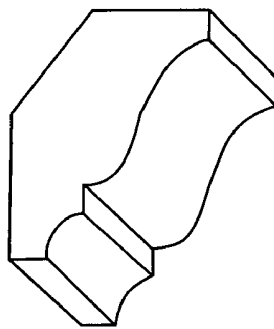

**1101**

$5/8 \times 1-5/8$

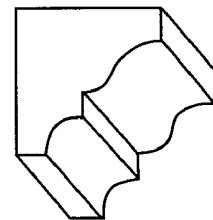

**1100**

$3/4 \times 3/4$

CROWNS

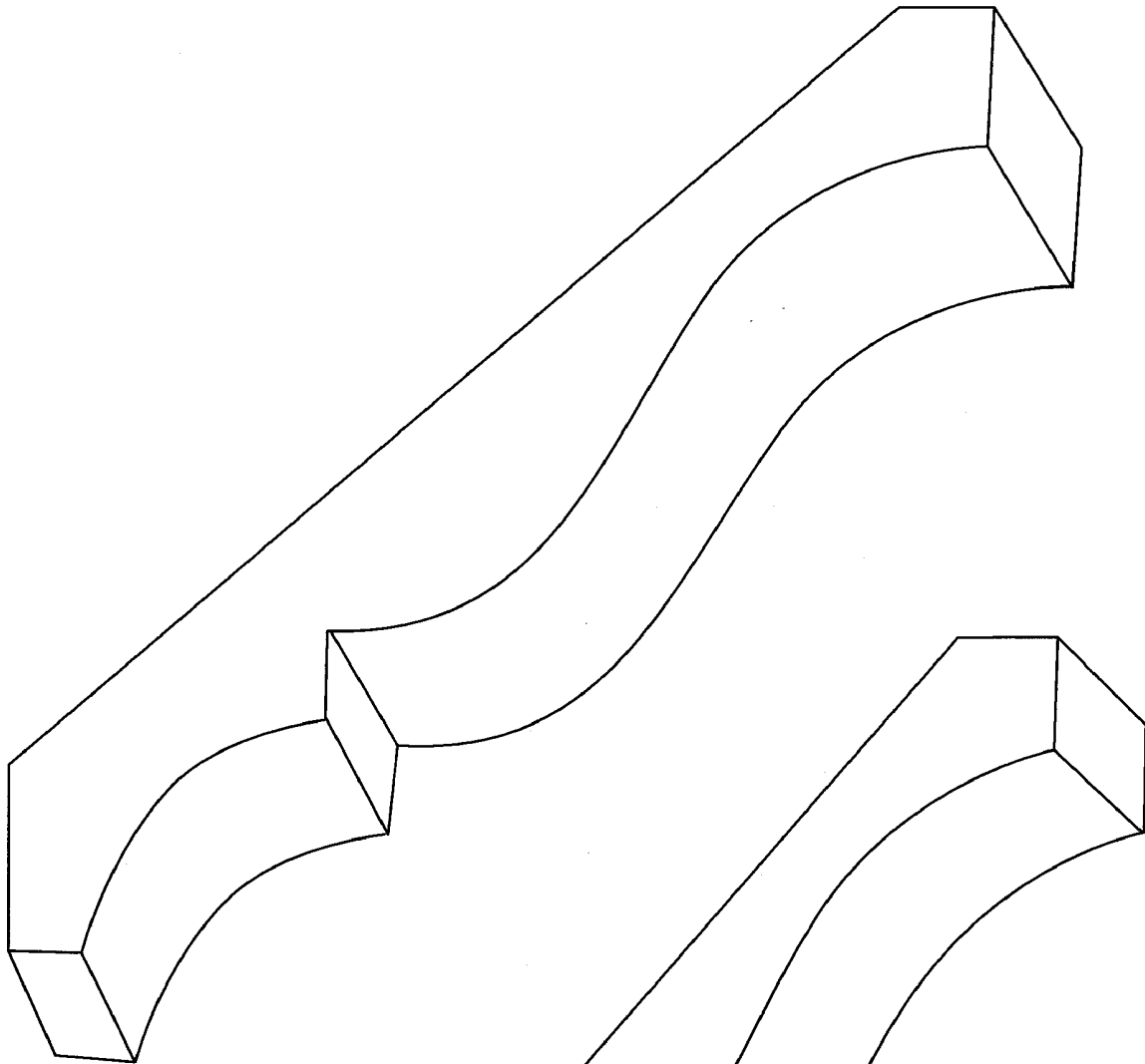

**1134**

7/8 x 7-1/8

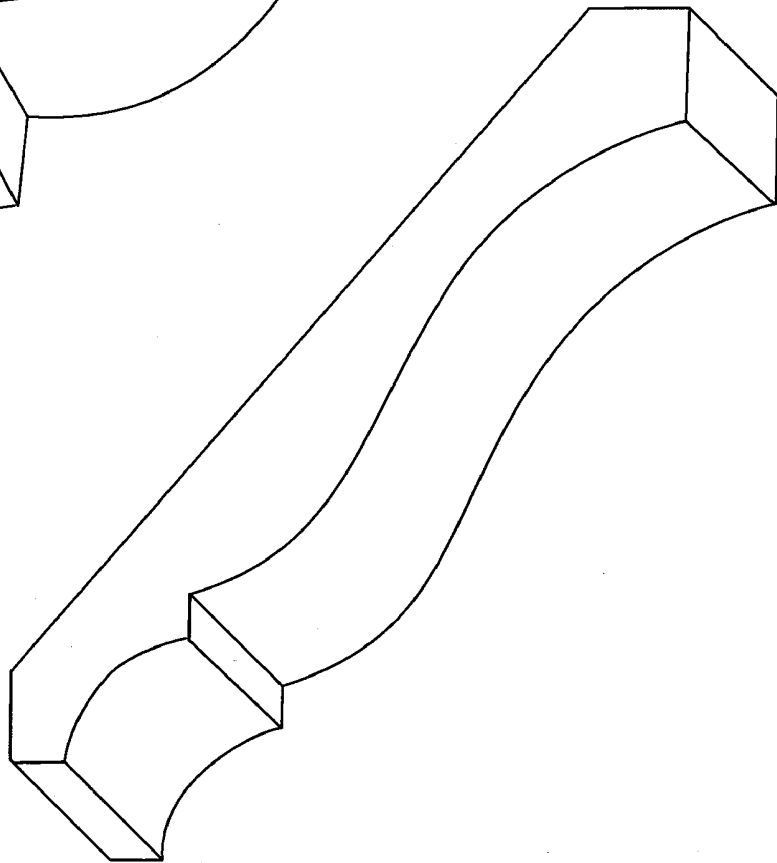

**1105**

11/16 x 5-1/4

CROWNS

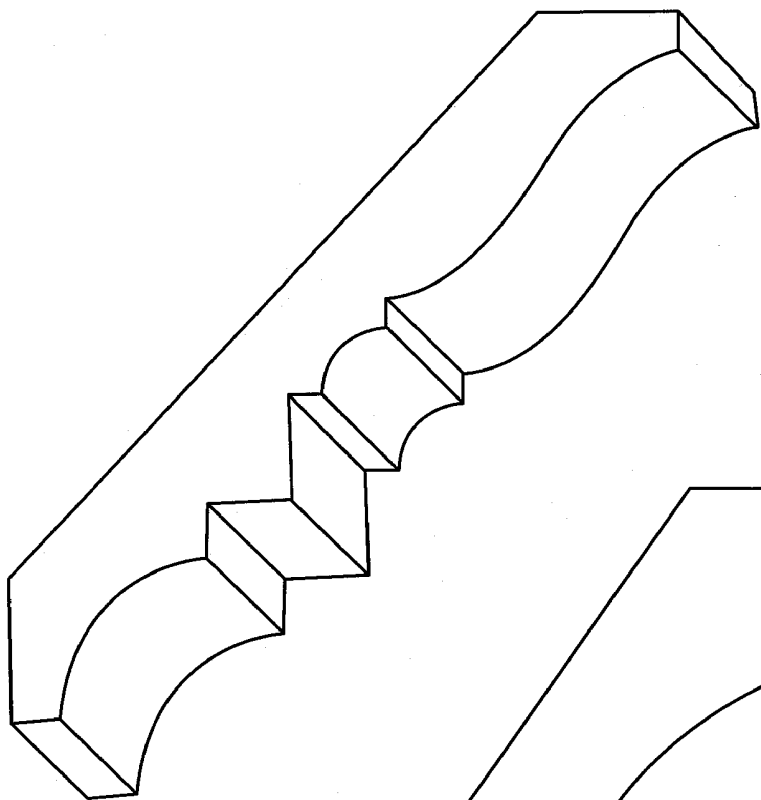

**1106**

3/4 x 5

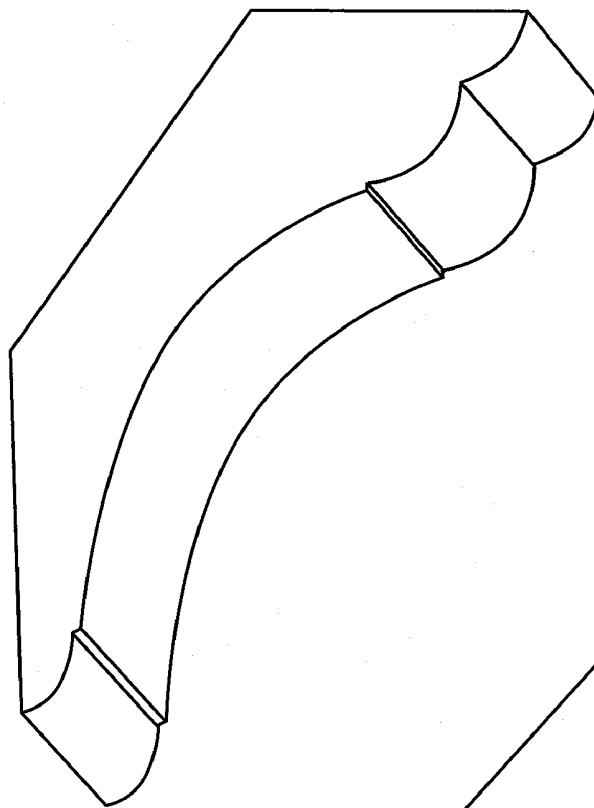

**1111**

1-1/8 x 4-7/16

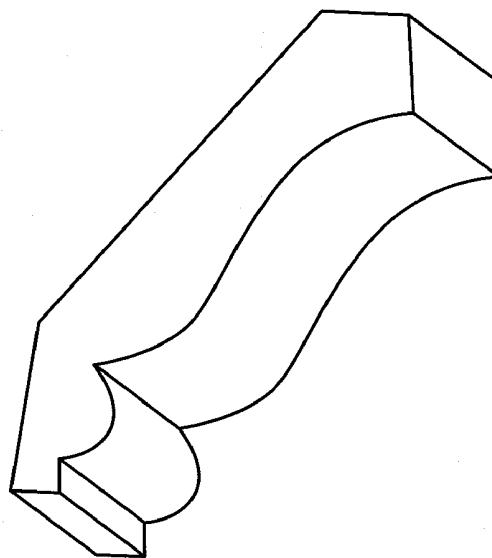

**1109**

11/16 x 3-3/16

CROWNS

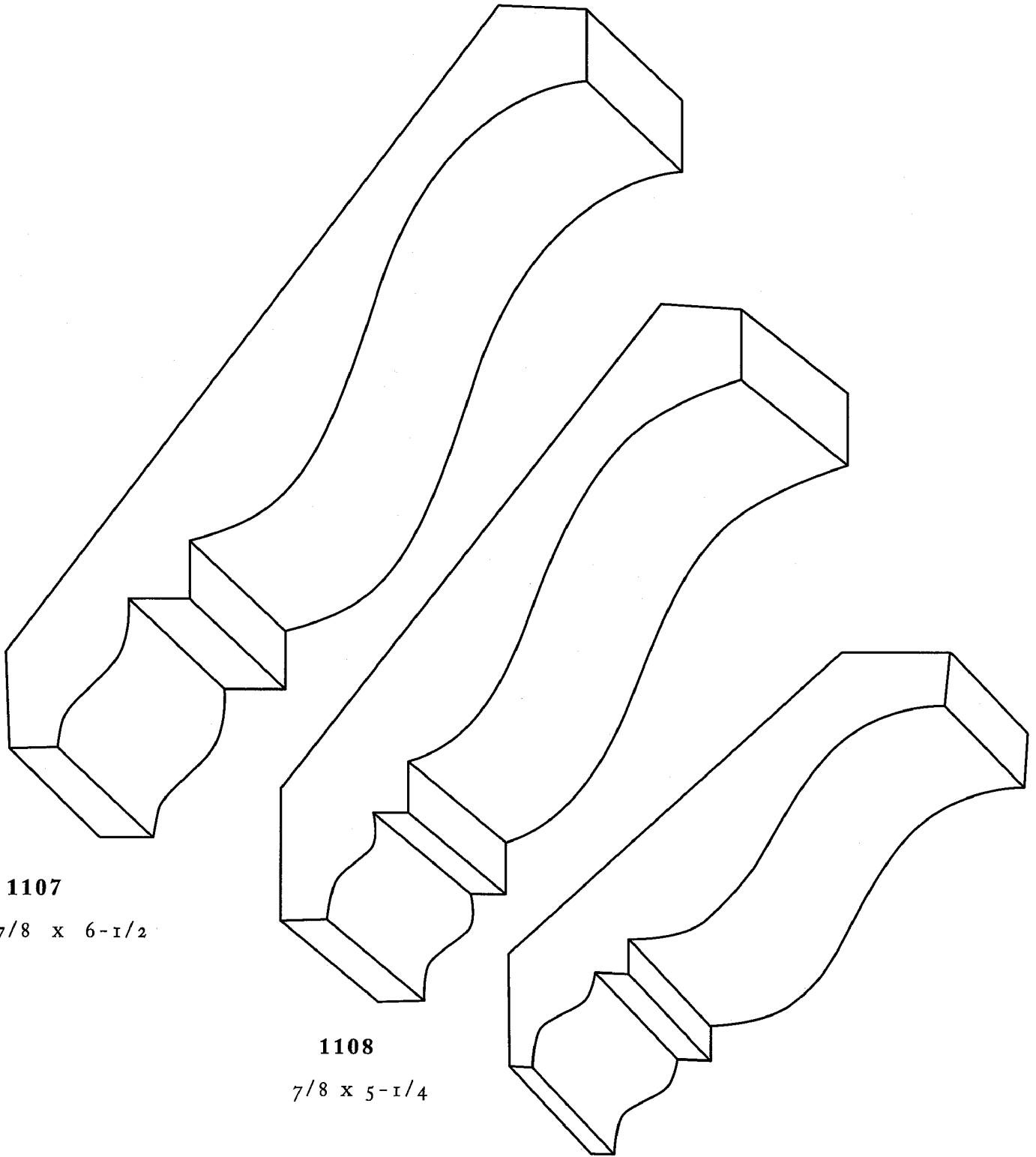

**1107**

7/8 x 6-1/2

**1108**

7/8 x 5-1/4

**1116**

3/4 x x 4-1/8

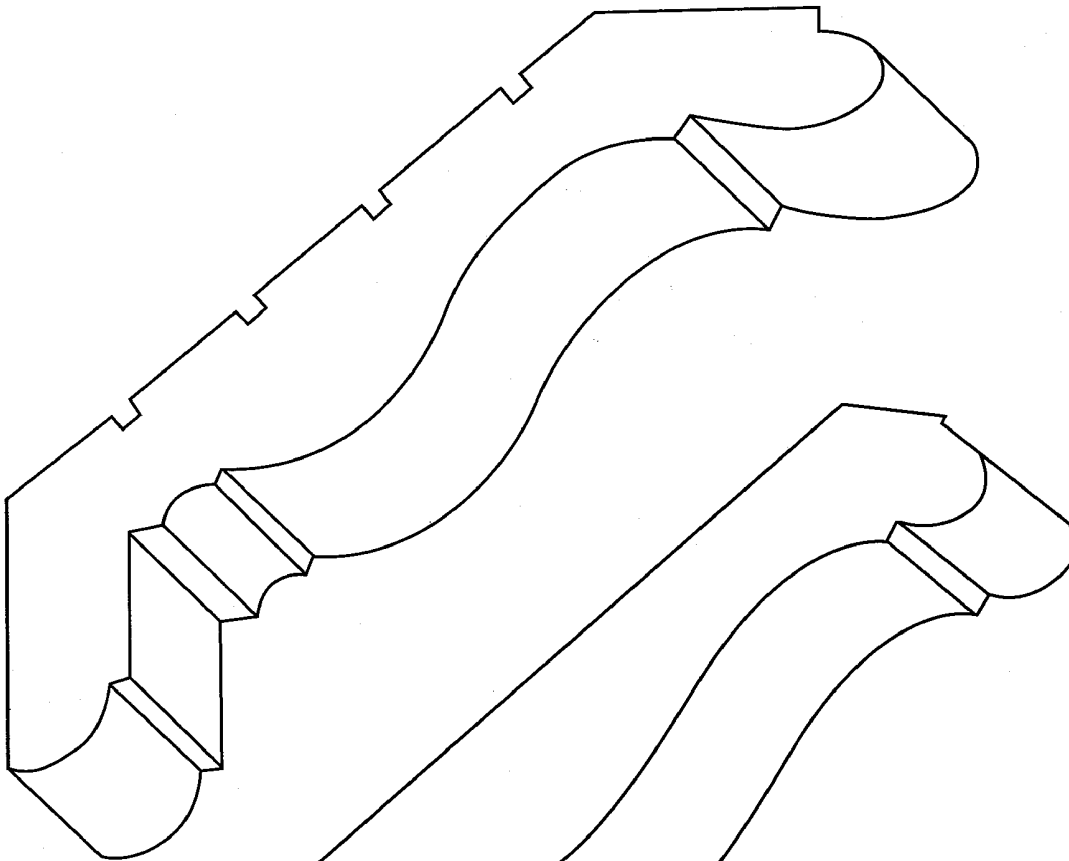

**1113**

1-1/4 x 5-3/4

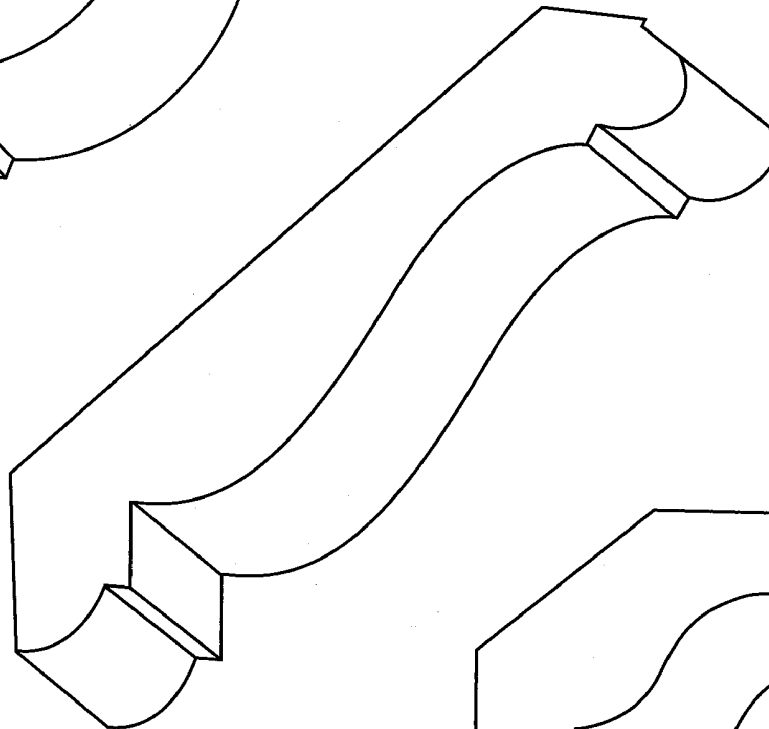

**1112**

3/4 x 4-9/16

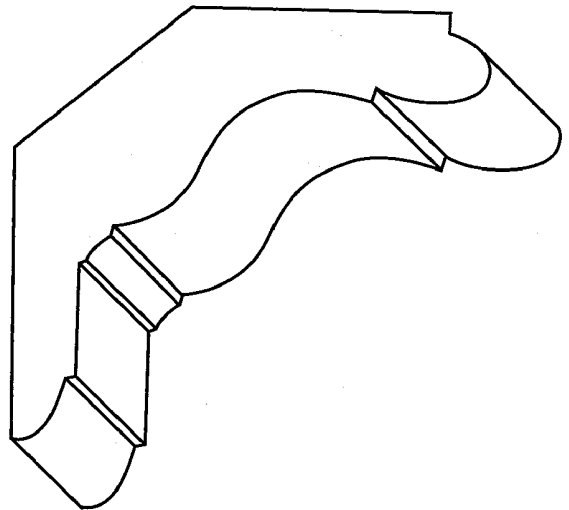

**1110**

1-1/4 x x 3-1/8

CROWNS

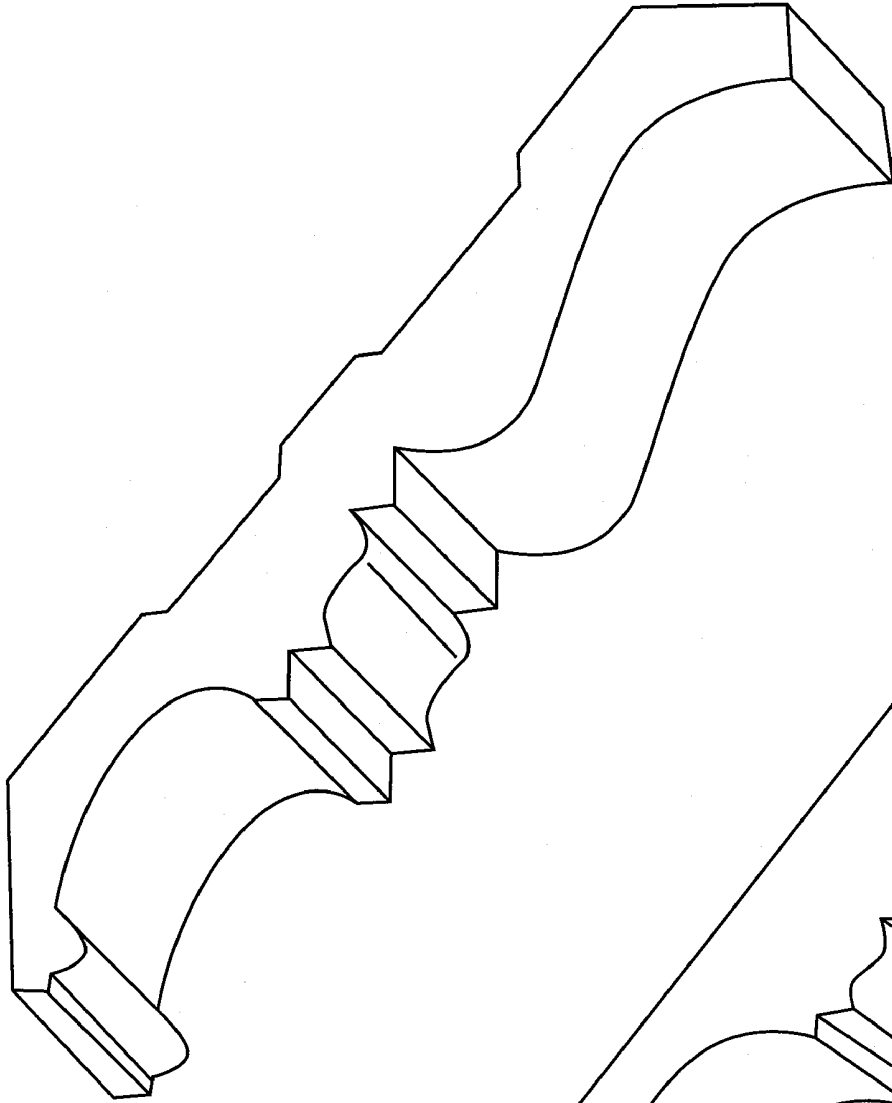

**1115**  
7/8 x 6-1/2

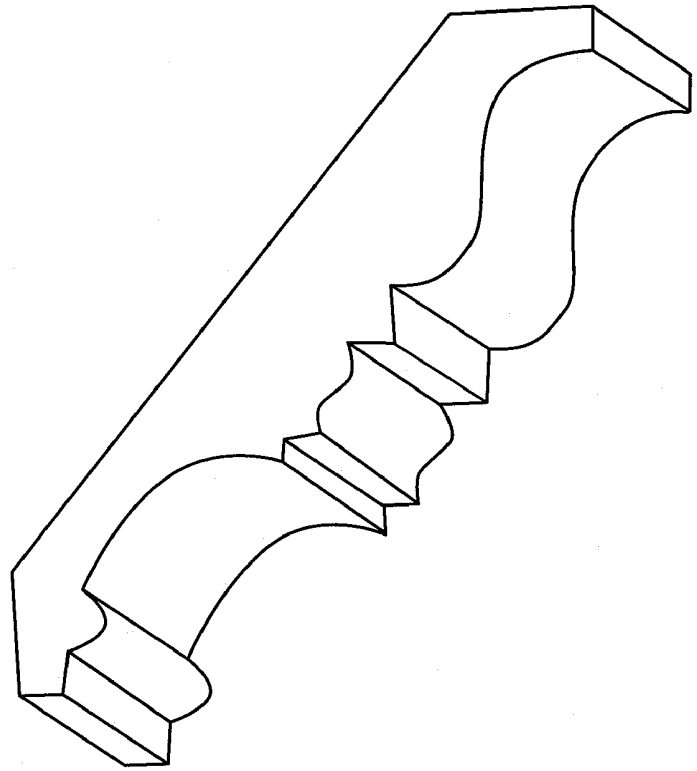

**1114**  
7/8 x 4-5/8



CROWNS

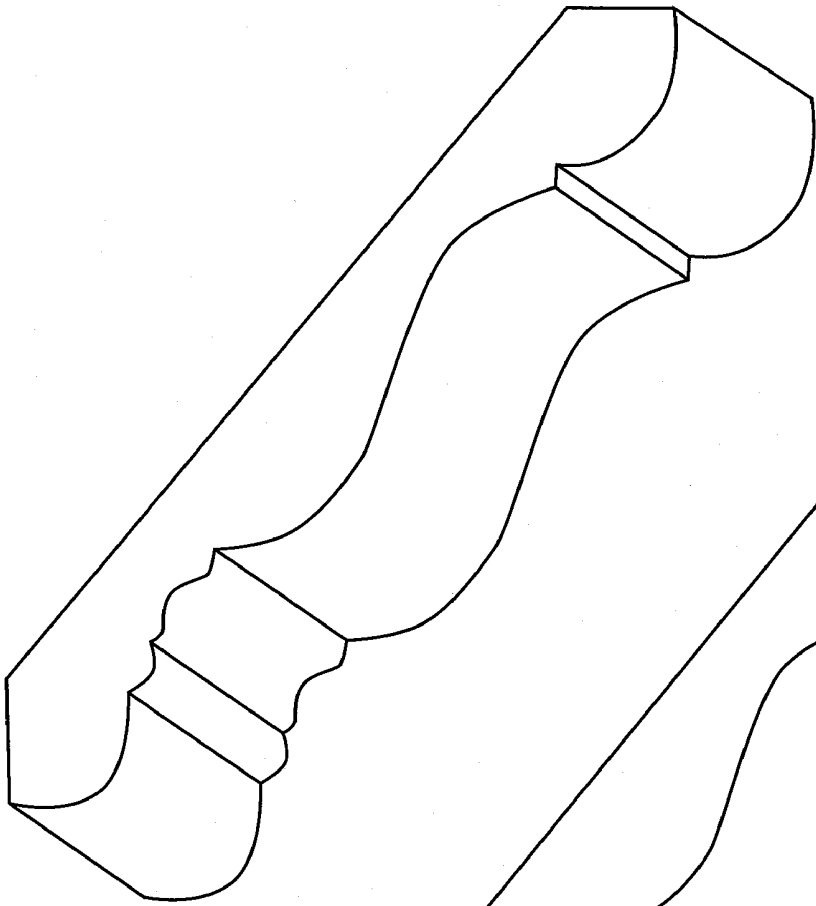

**1119**

$3/4 \times 5-3/8$

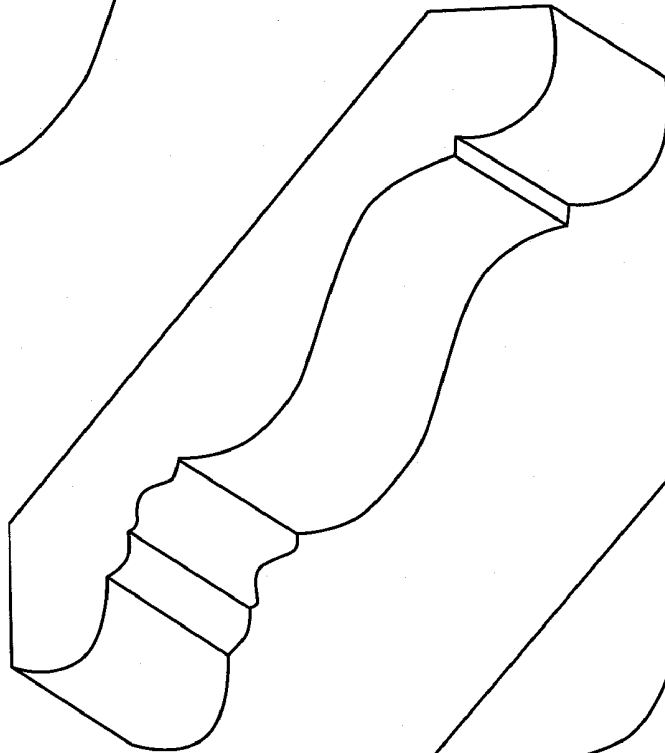

**1118**

$3/4 \times 4-3/8$

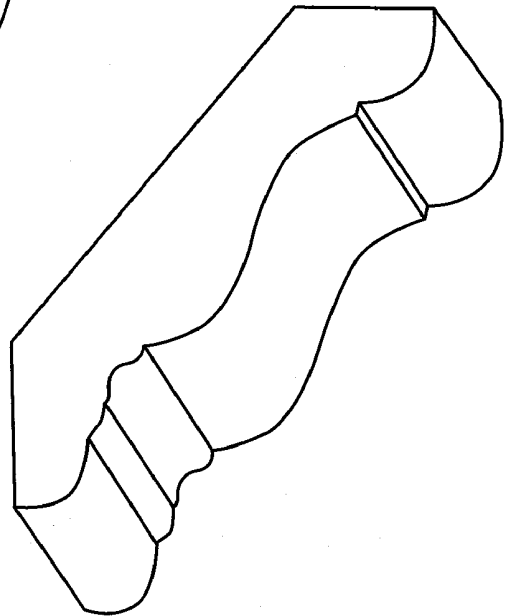

**1117**

$3/4 \times 3-3/8$

CROWNS

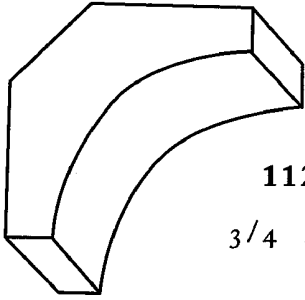

**1120**  
3/4 x 1-3/4

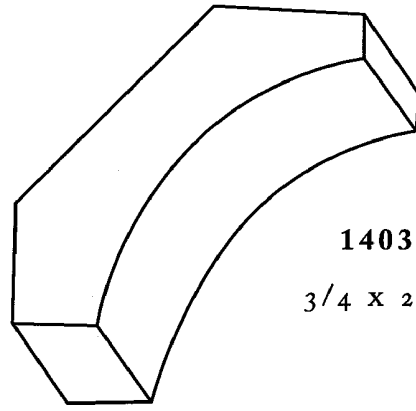

**1403**  
3/4 x 2-7/16

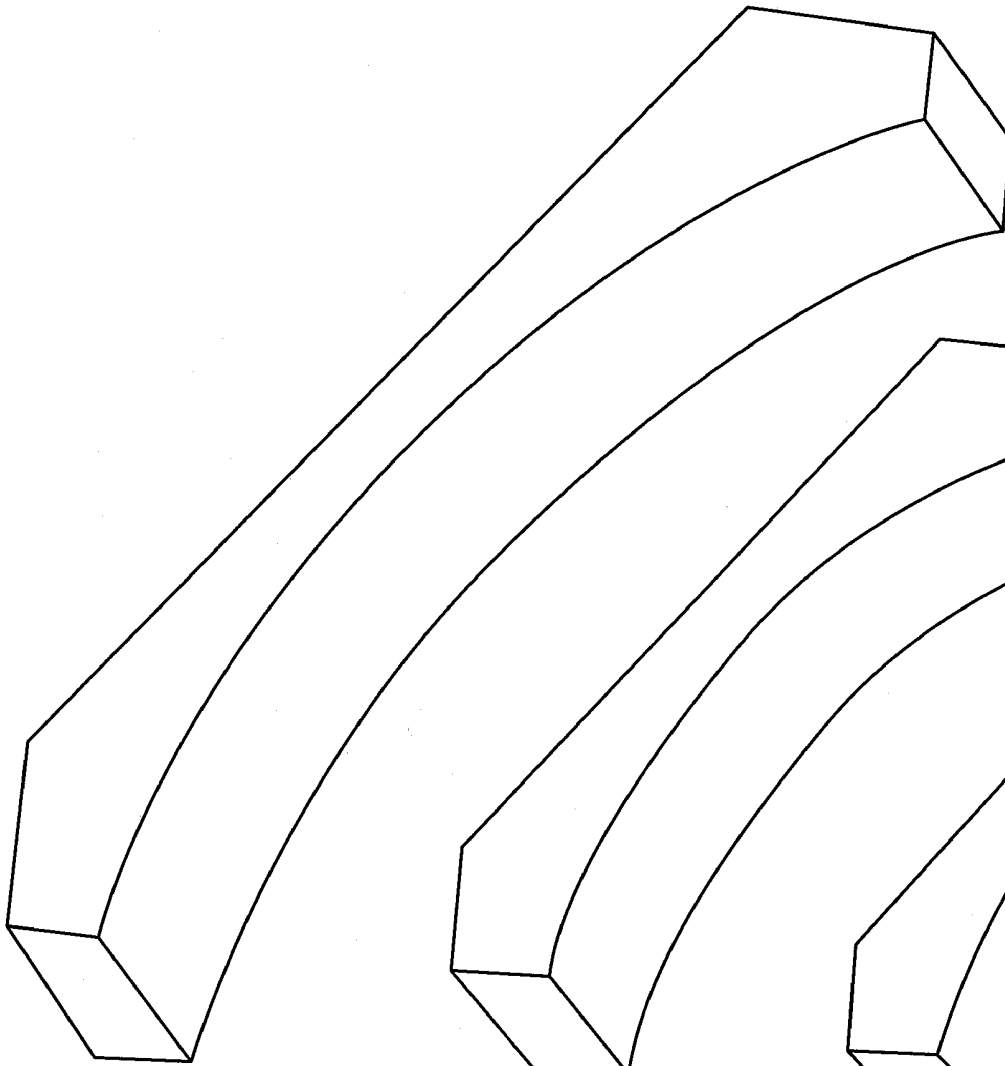

**1123**  
1-1/16 x 6-3/4

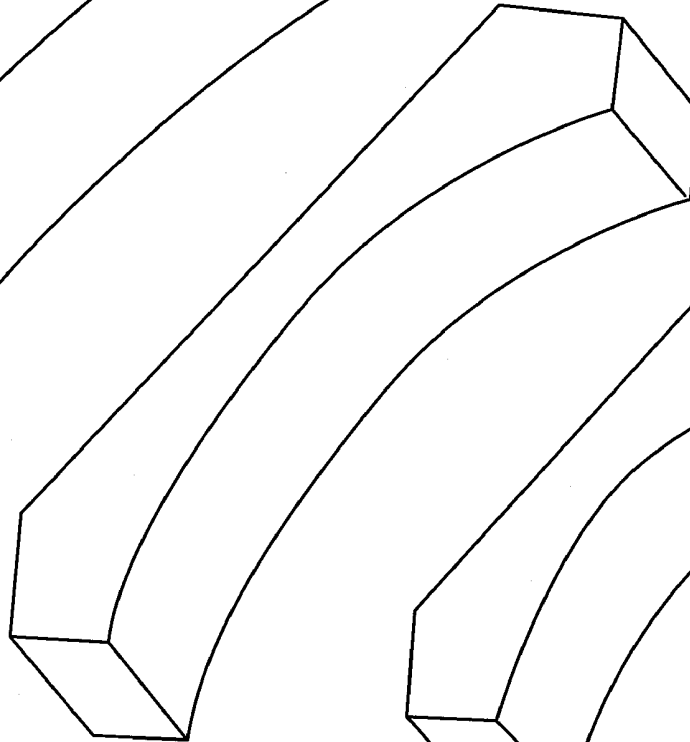

**1122**  
13/16 x 4-1/2

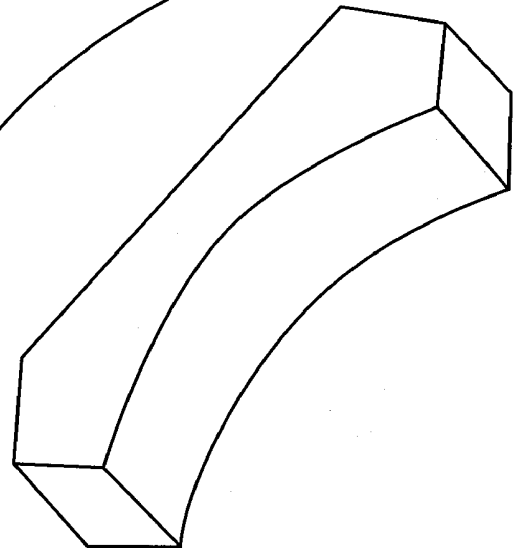

**1121**  
11/16 x 3-3/16

CROWNS

1125

$7/8 \times 4-15/16$

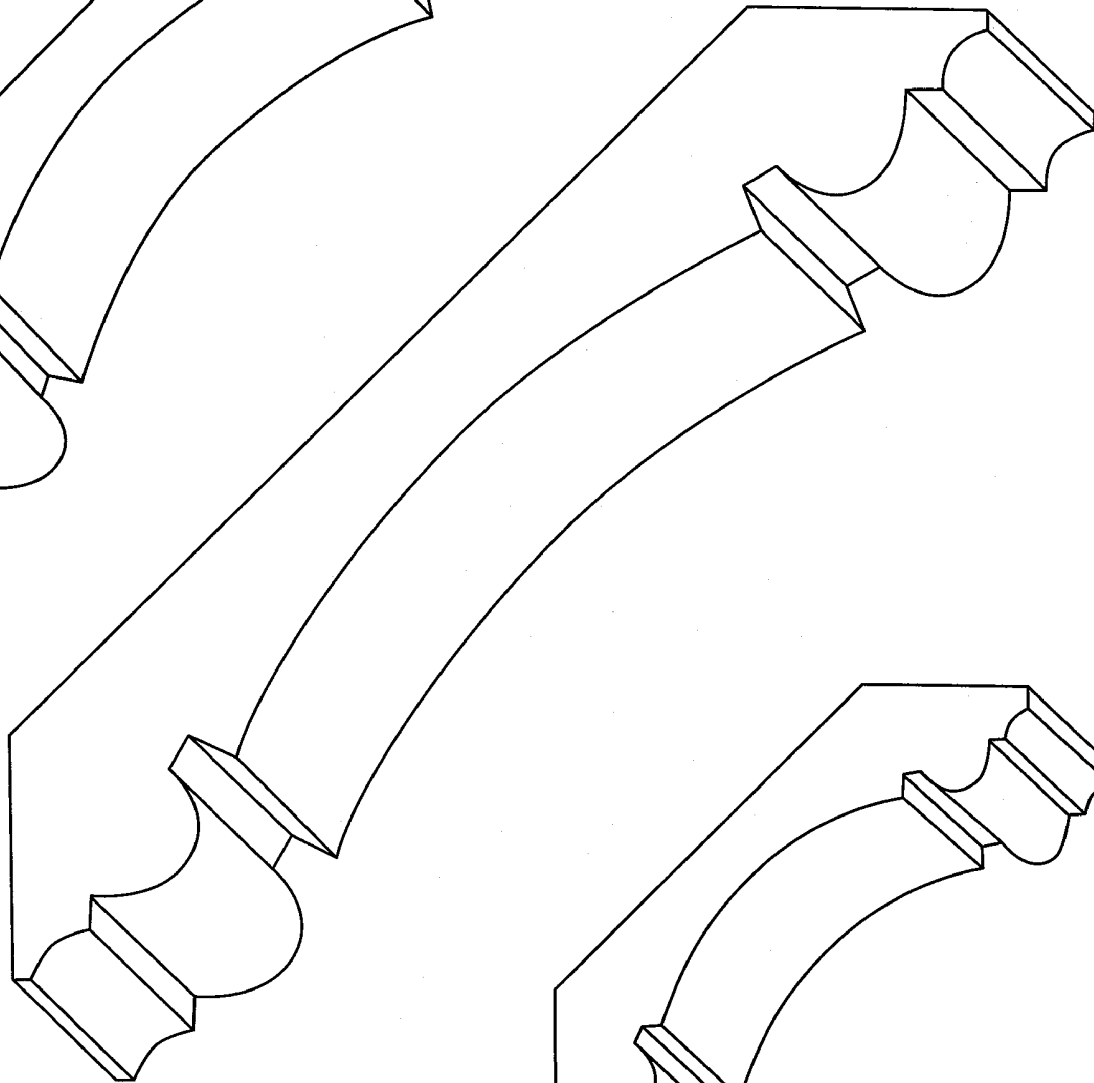
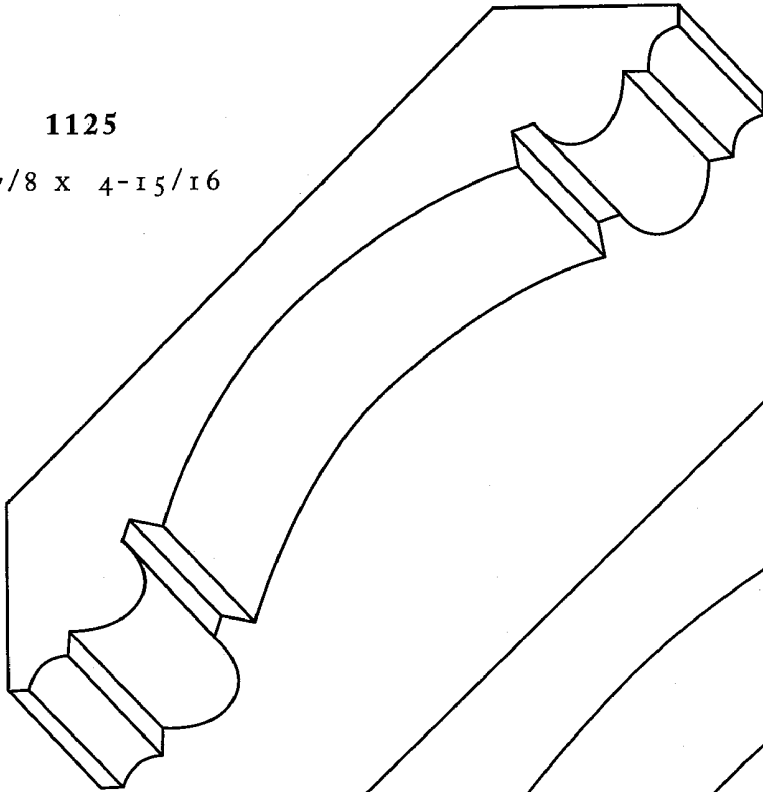

1126

$1-1/8 \times 7-1/8$

1124

$3/4 \times 3-7/16$

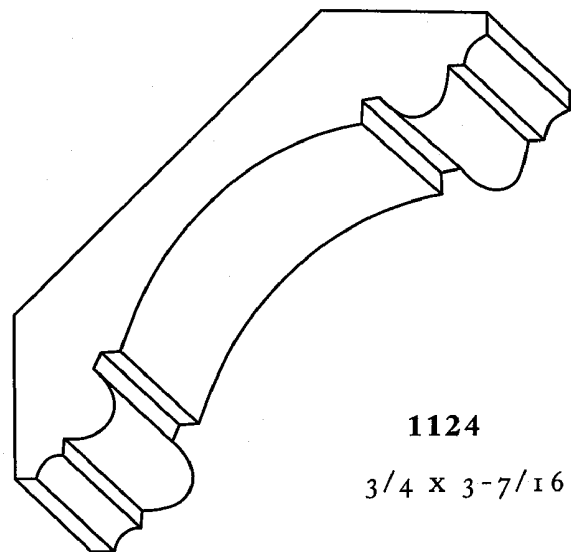

CROWNS

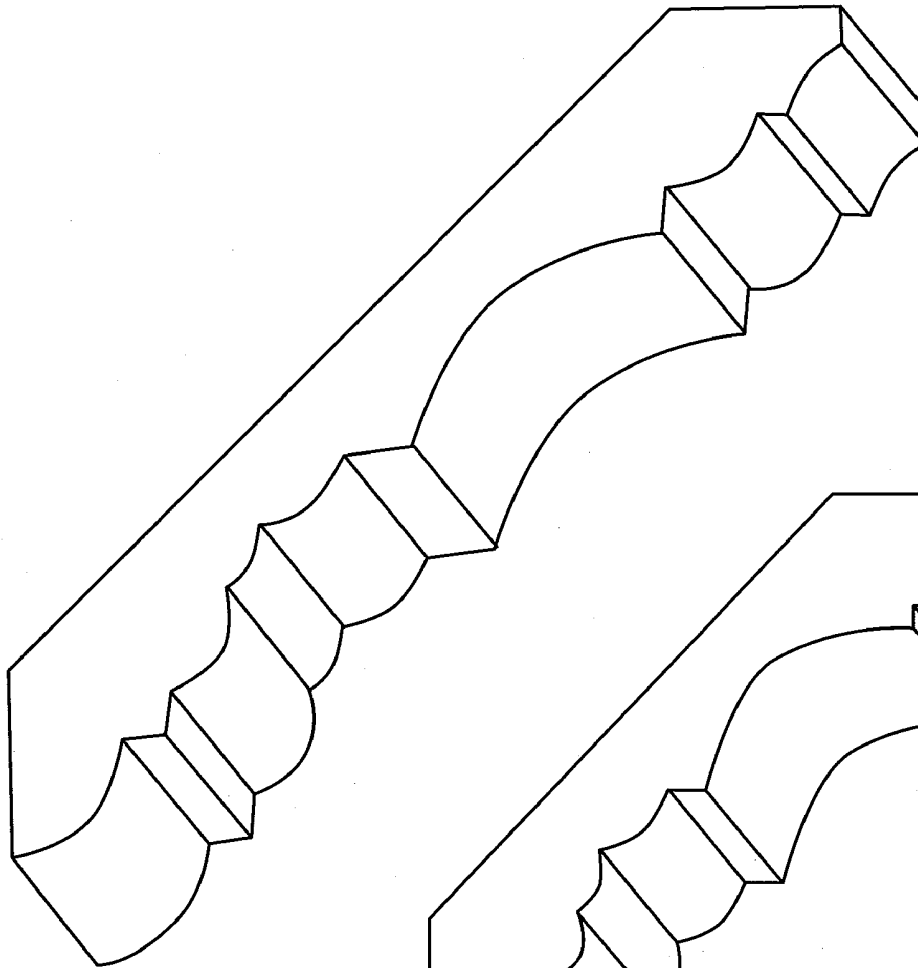

**1129**  
7/8 x 6-1/8

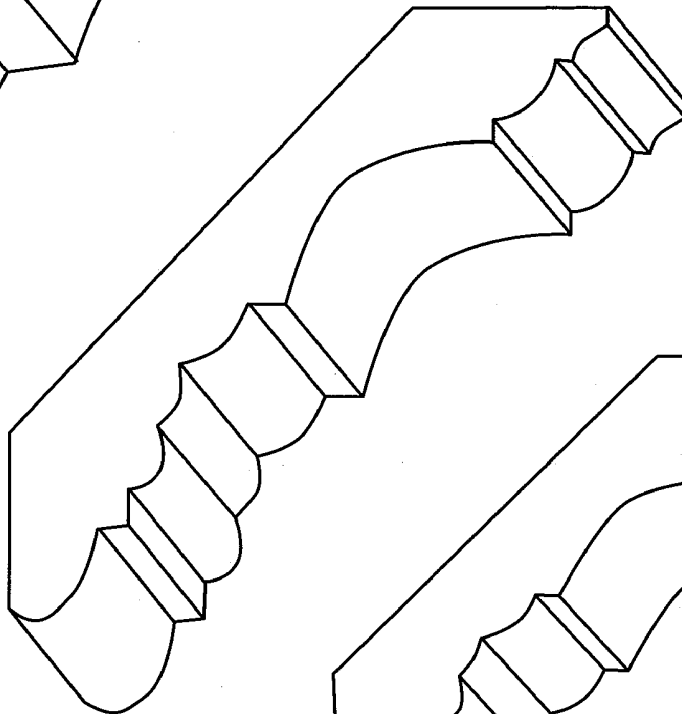

**1128**  
13/16 x 4-7/16

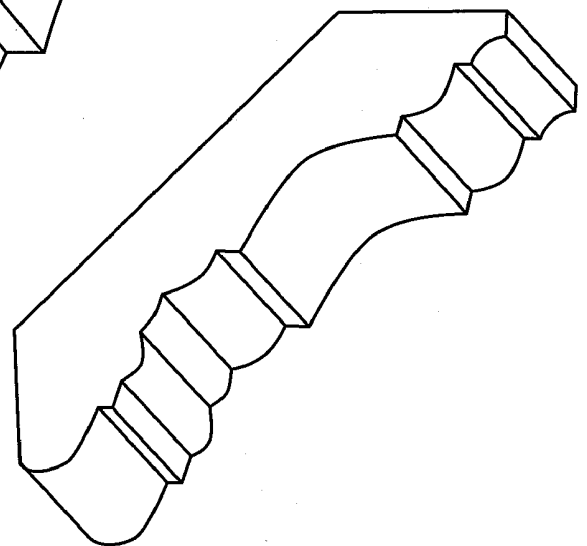

**1127**  
11/16 x 3-7/16

1132

7/8 x 4-5/8

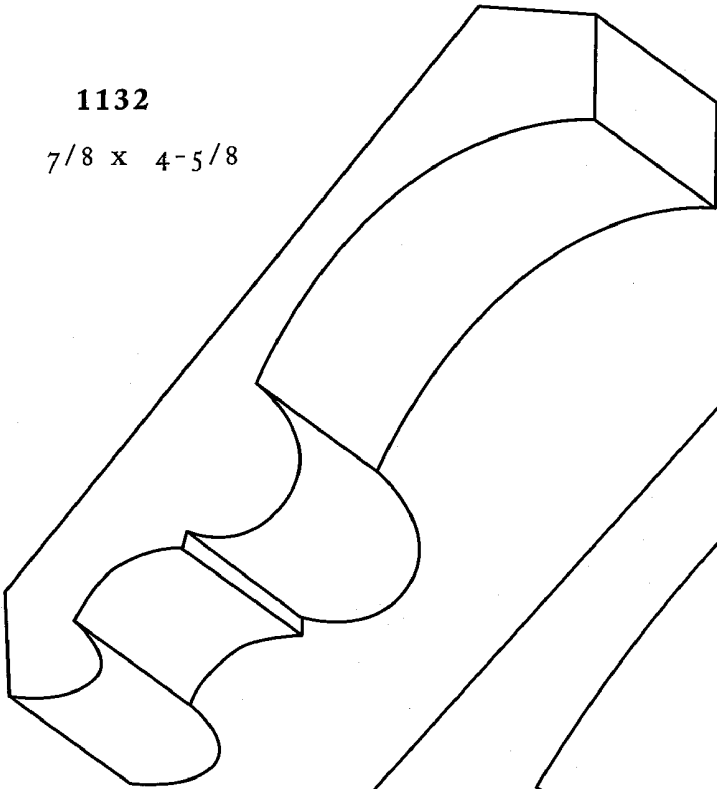

1133

7/8 x 6-5/16

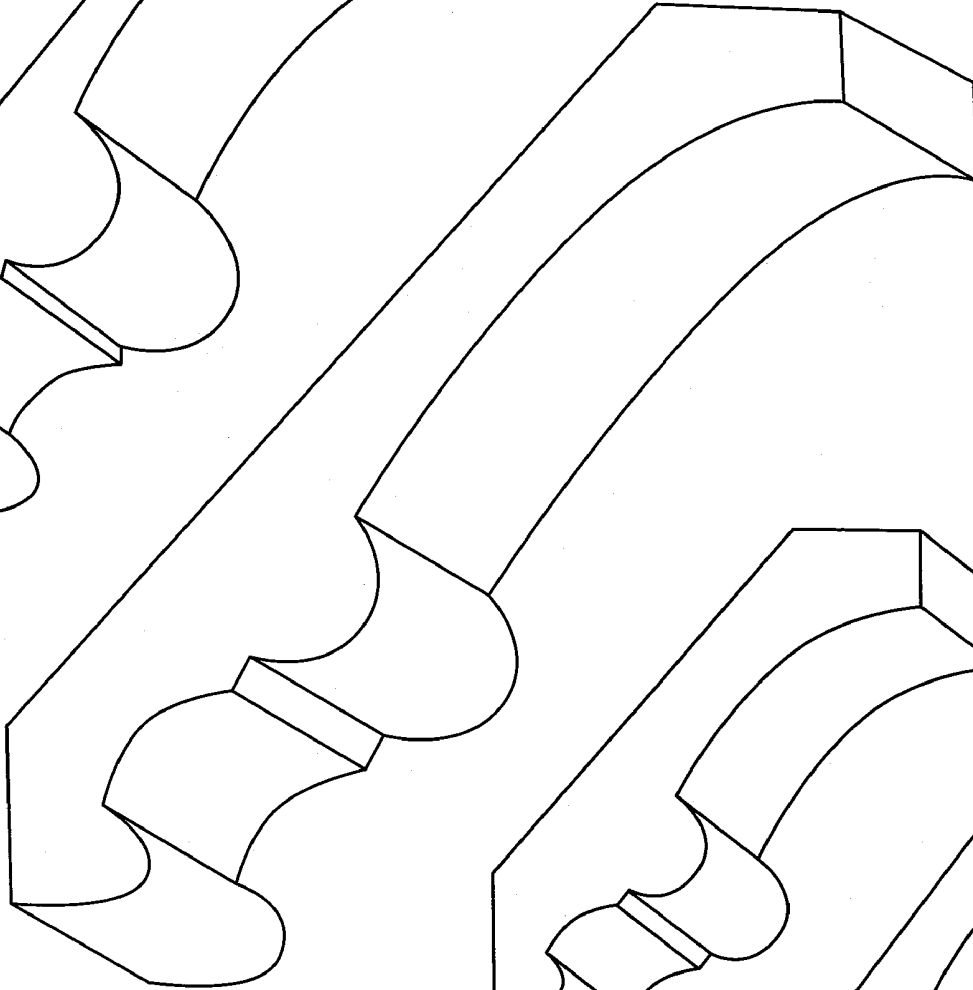

1131

3/4 x 3-1/4

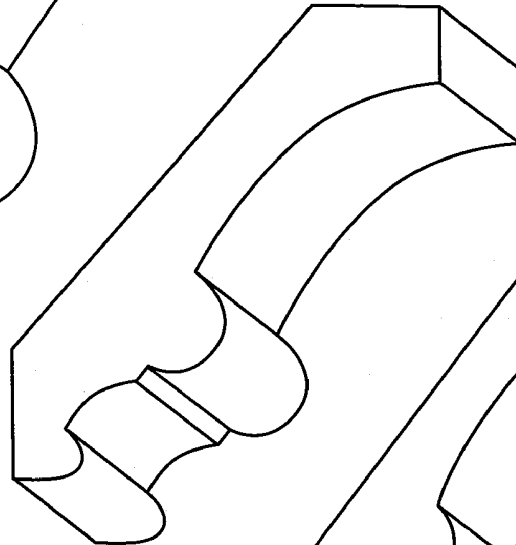

1130

5/8 x 2-3/4

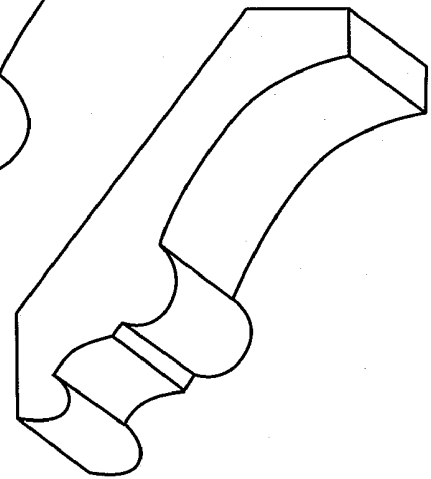

1136

7/8 x 5-1/2

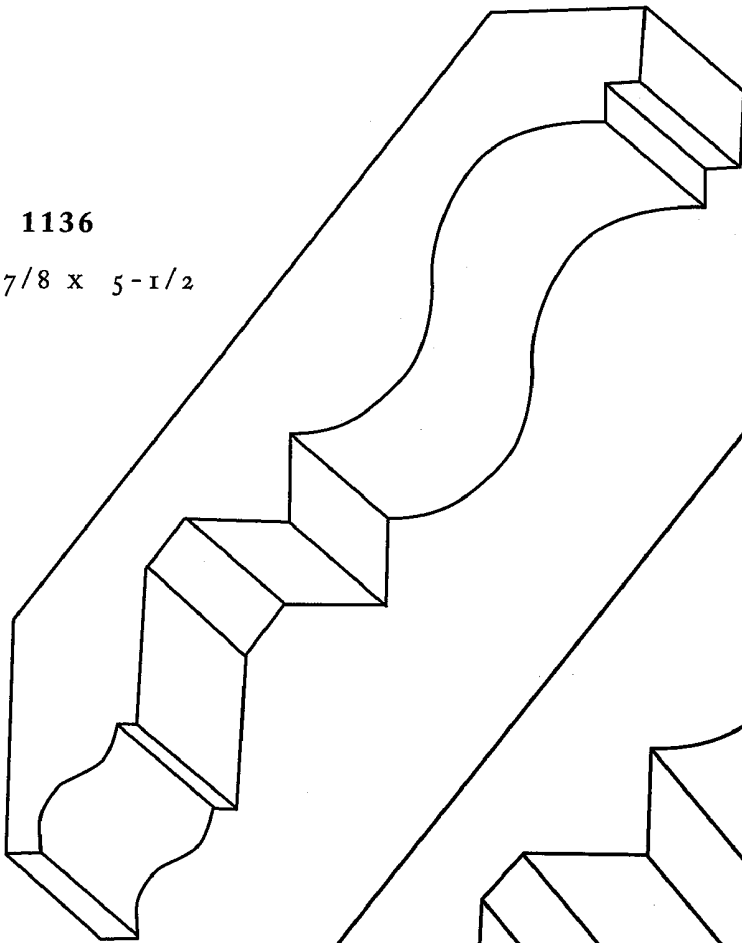

1137

1-1/16 x 6-7/8

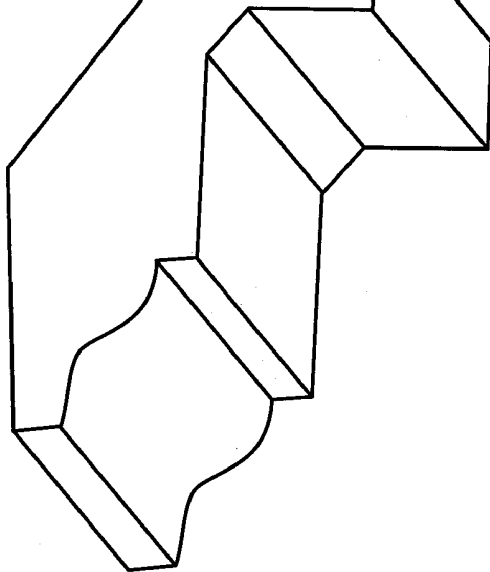

1135

3/4 x 3-5/8

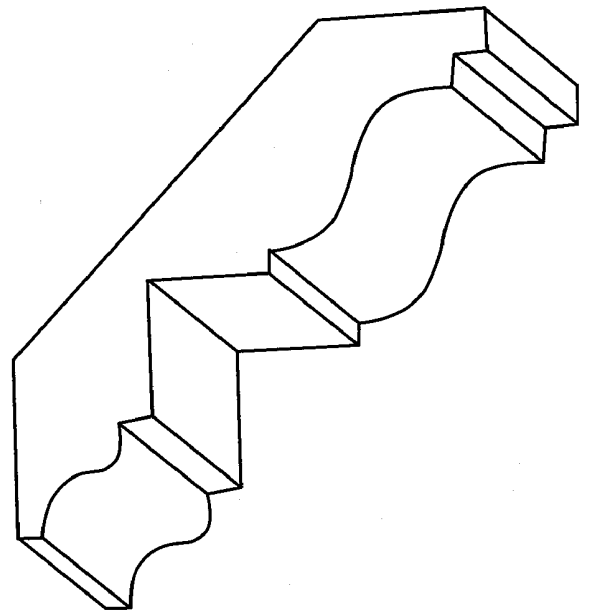

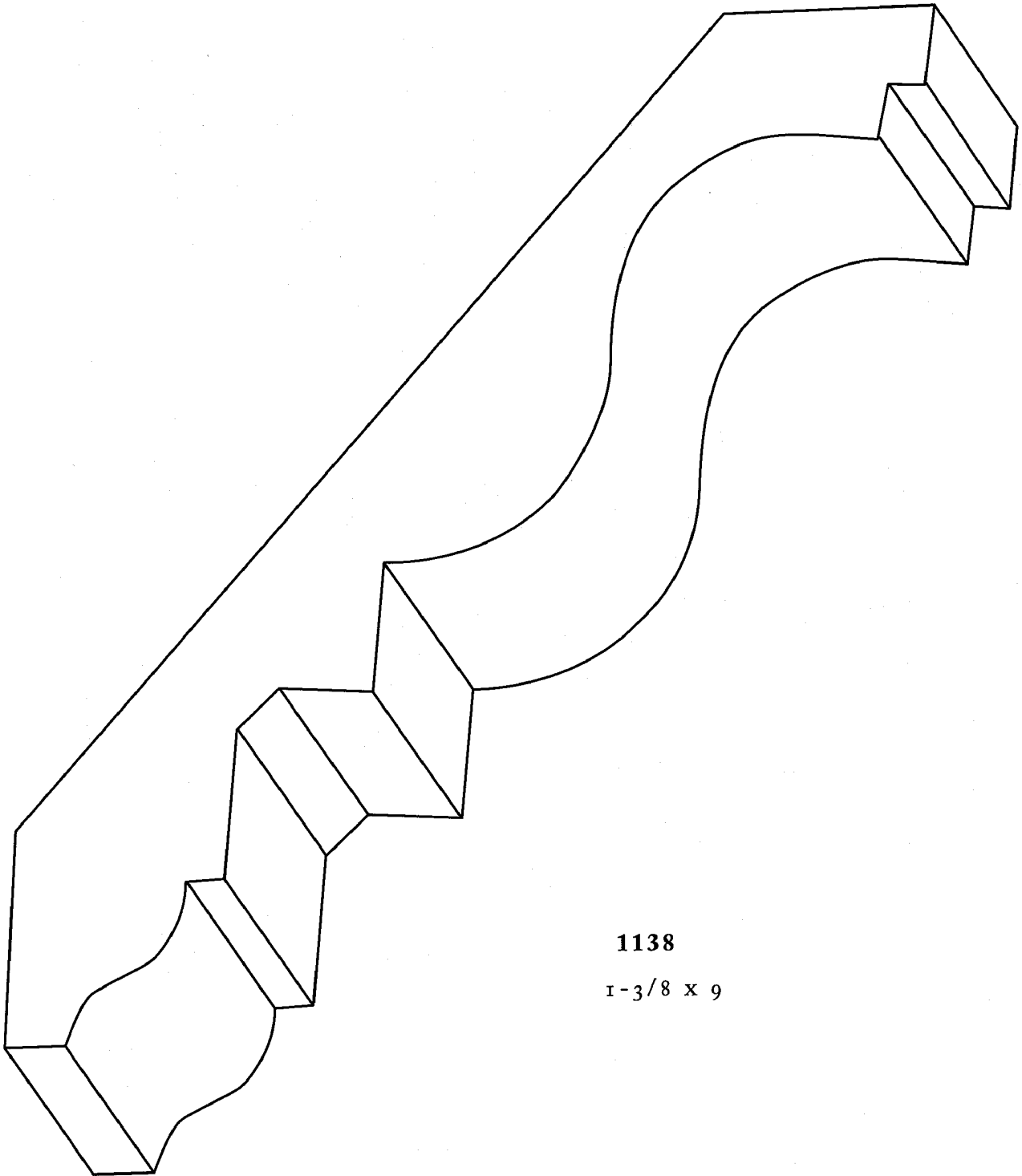

**1138**

1-3/8 x 9

**WB-5119**  
1-1/16 x 6-5/8

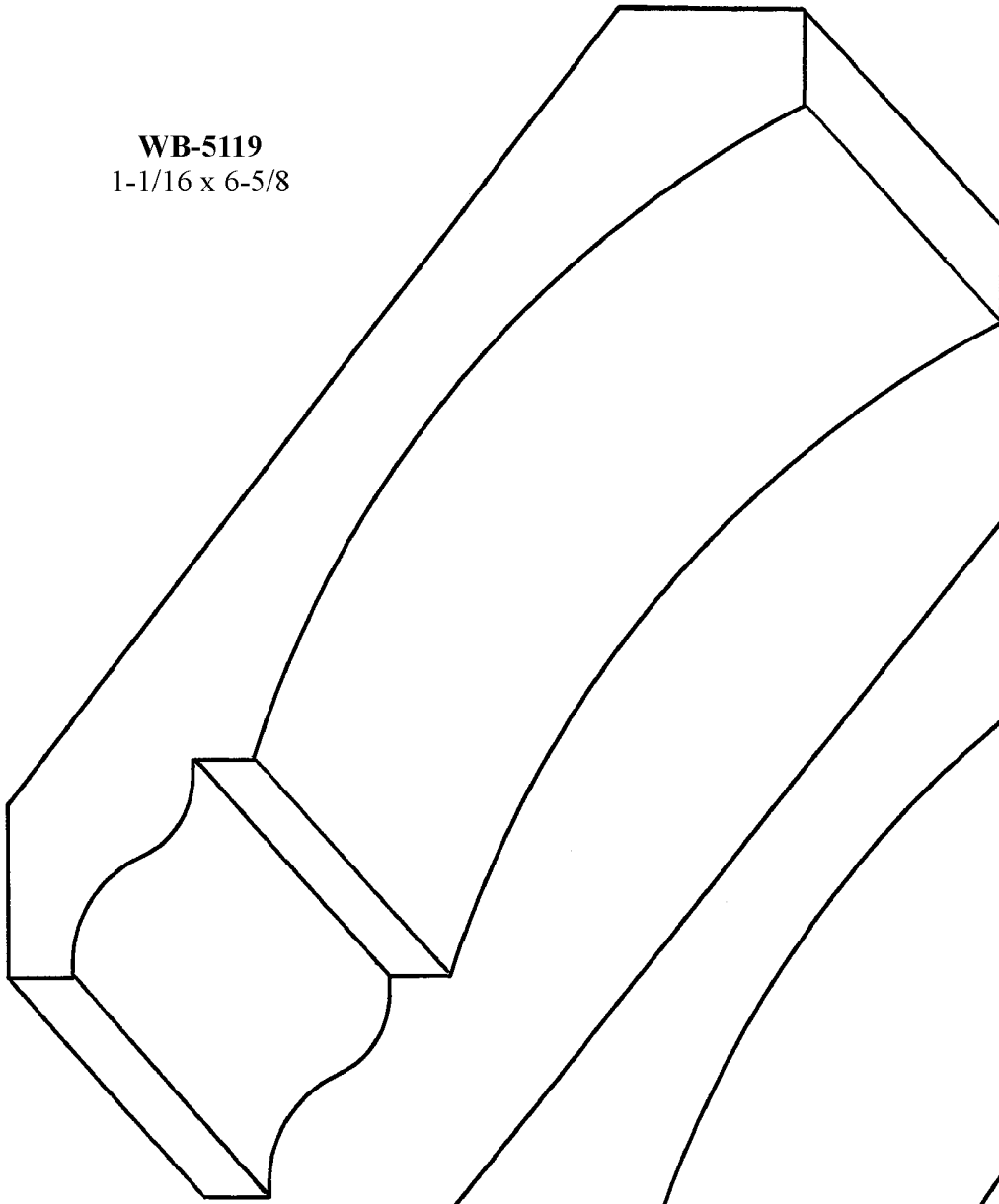

**WB-5116**  
1-1/16 x 6-5/8

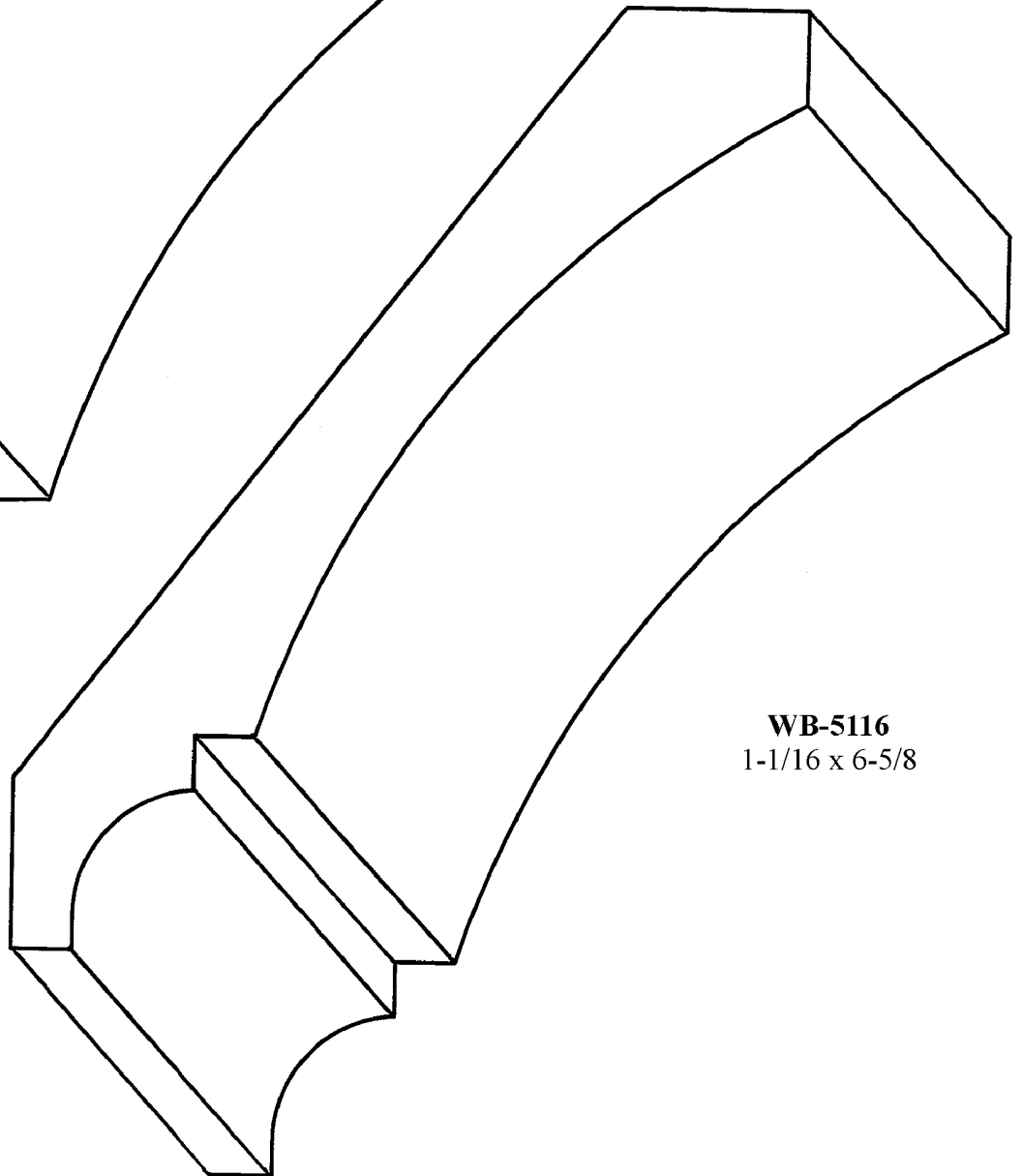



CROWNS

**1140**  
7/8 x 4-5/8

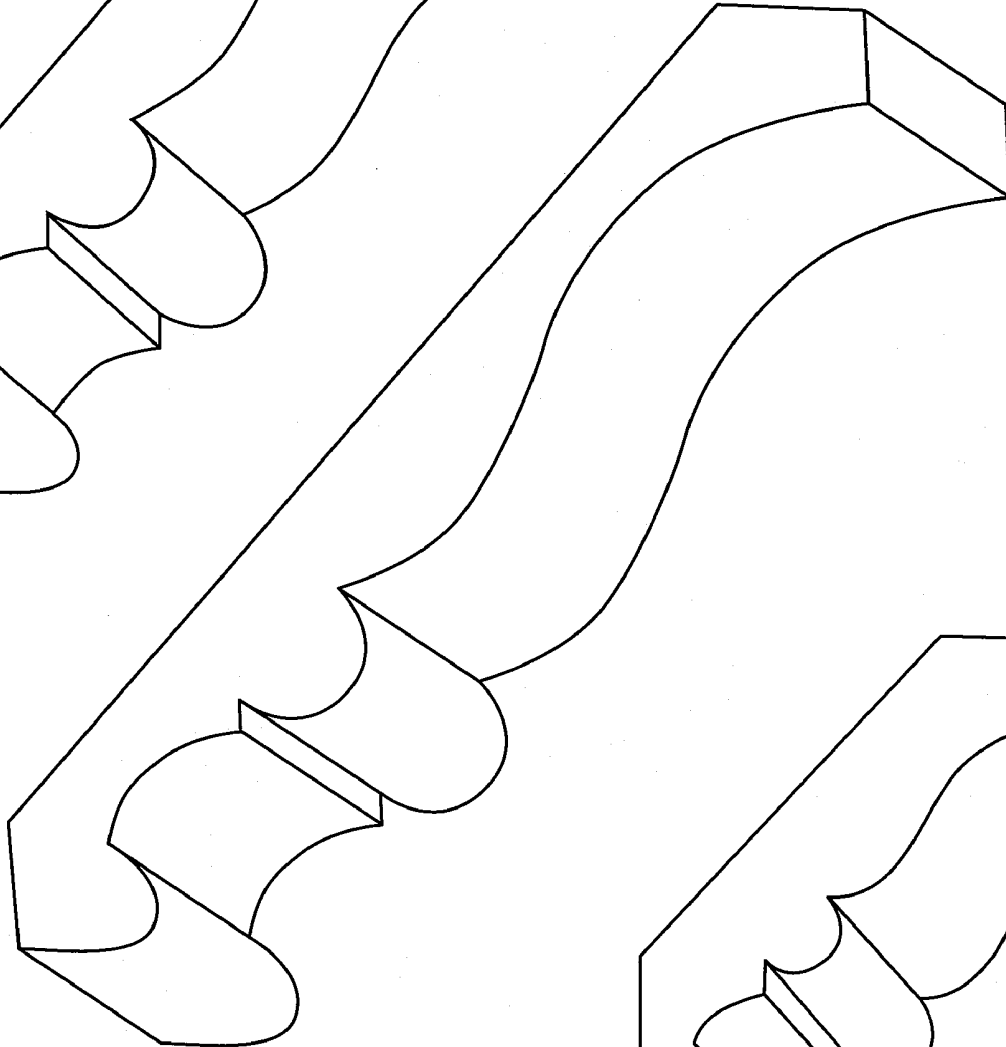
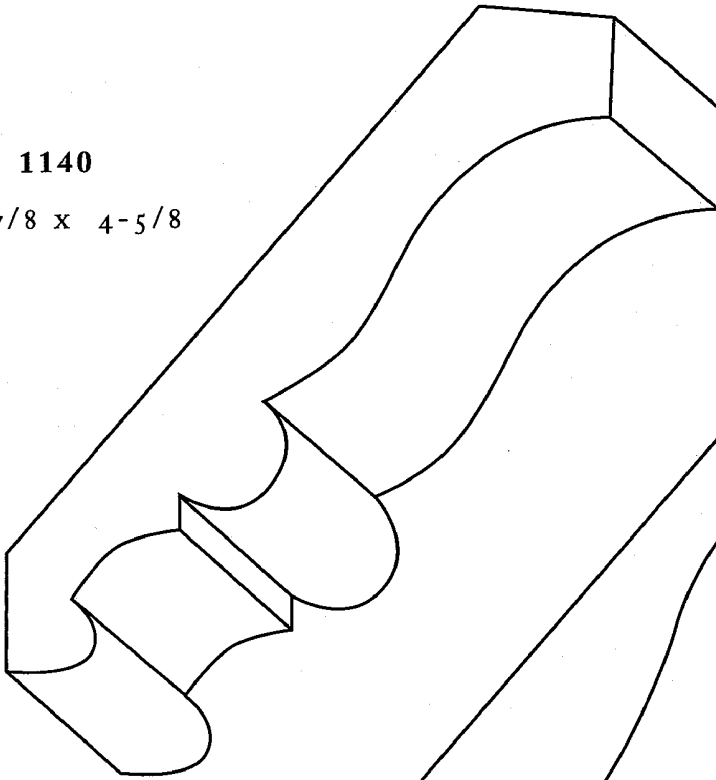

**1141**  
7/8 x 6-9/16

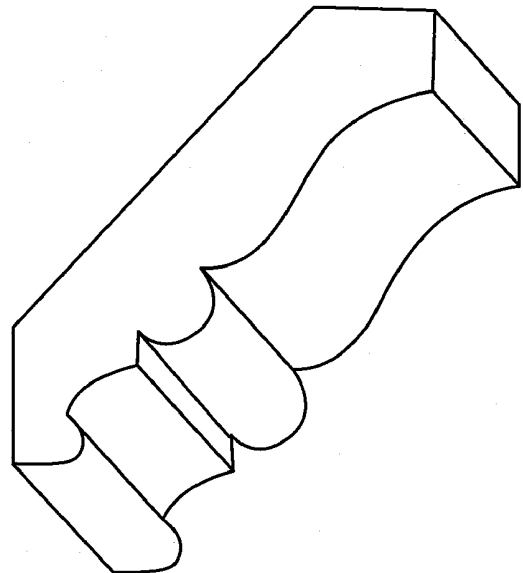

**1139**  
3/4 x 3-1/4

CROWNS

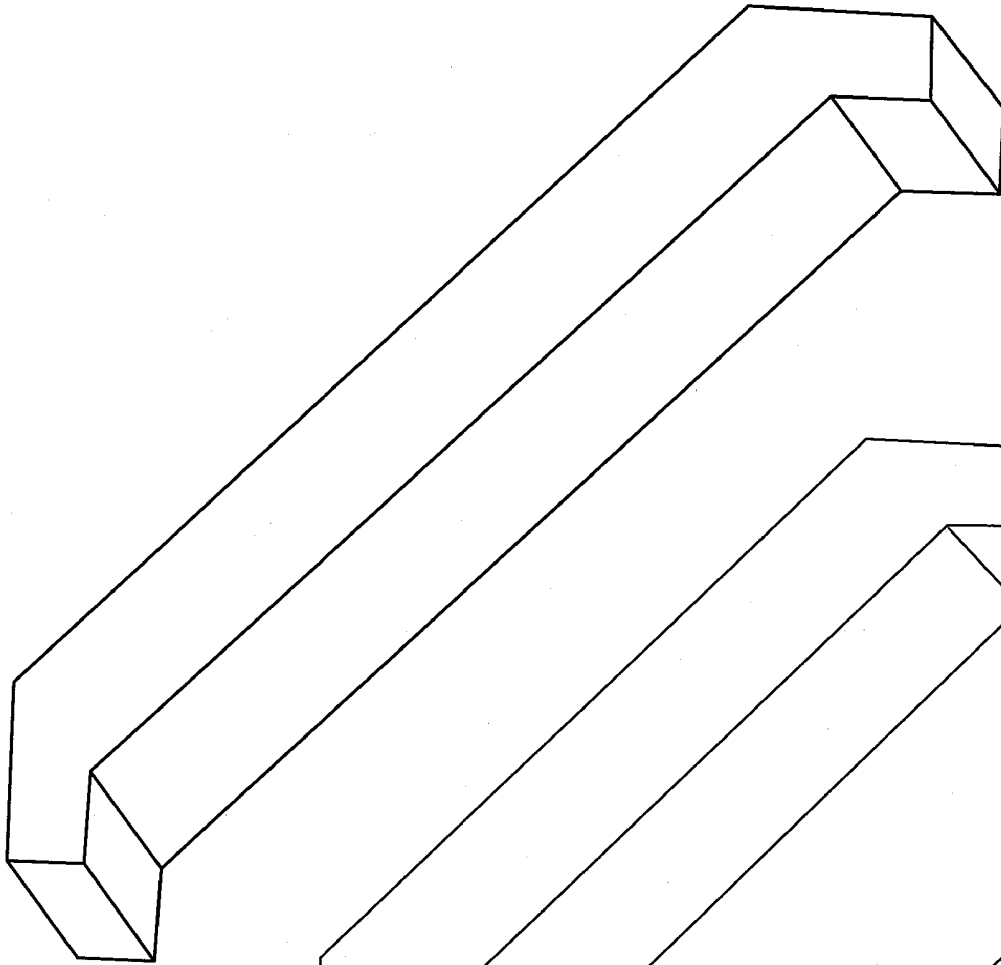

**1144**  
1 X 6-1/2

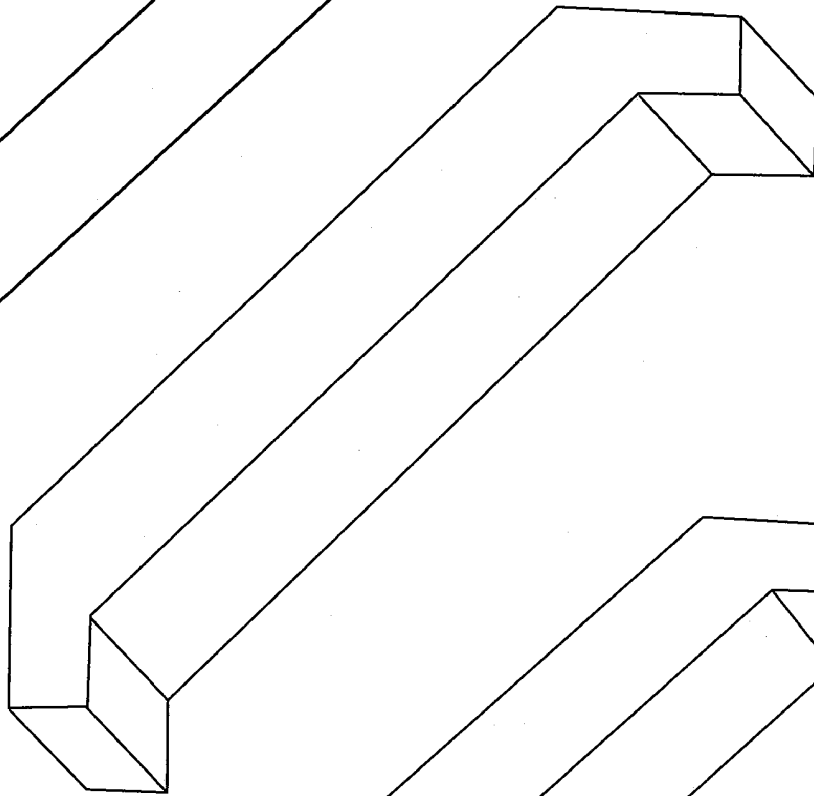

**1143**  
1 X 5-1/4

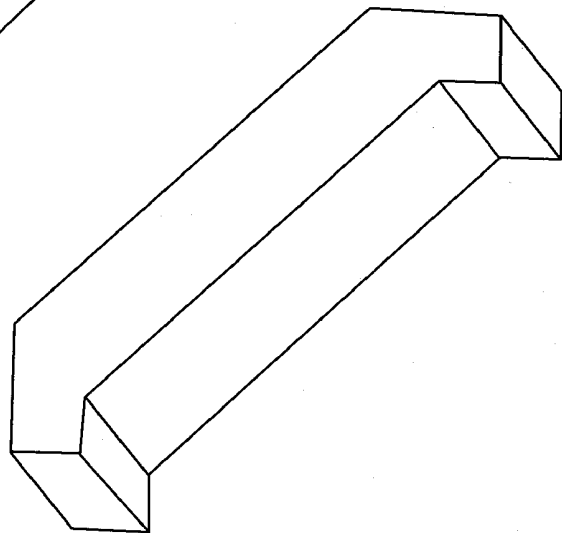

**1142**  
3/4 X 3-3/8

CROWNS

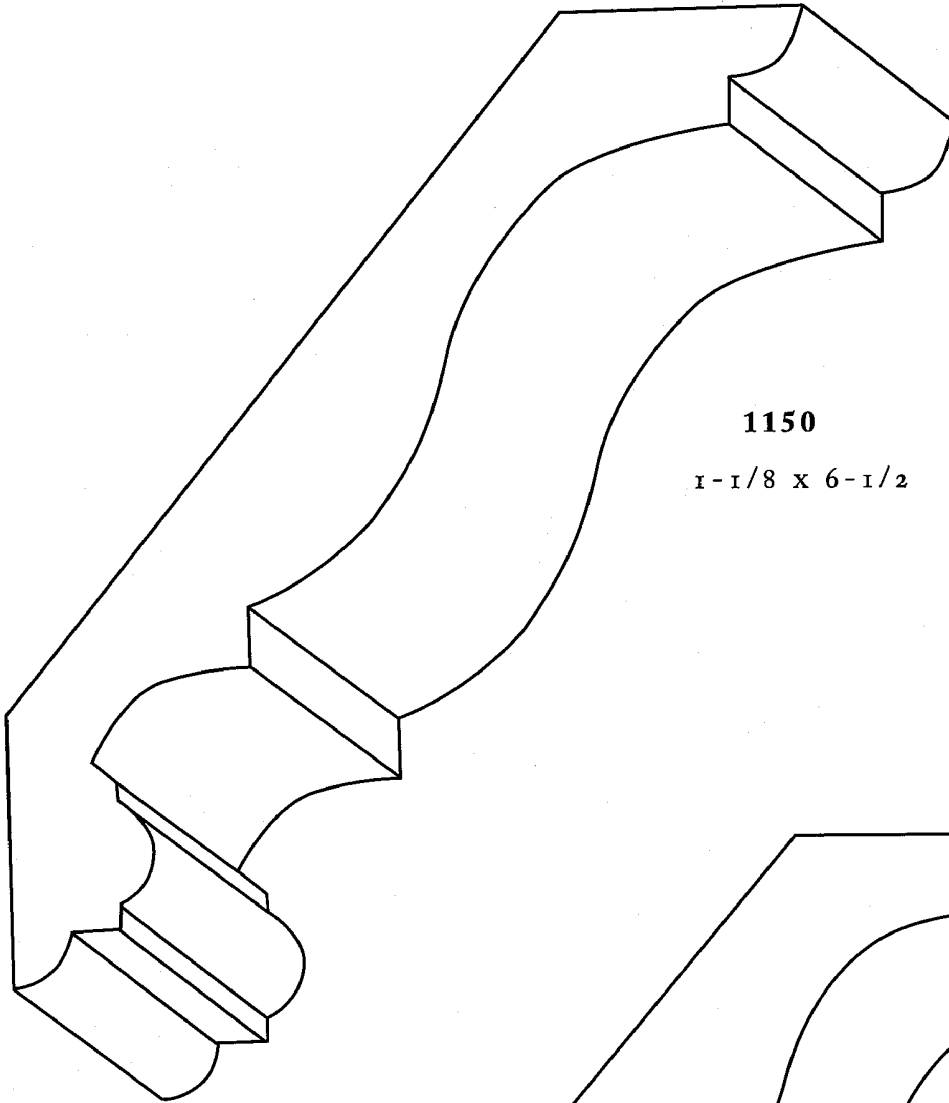

**1150**

1-1/8 X 6-1/2

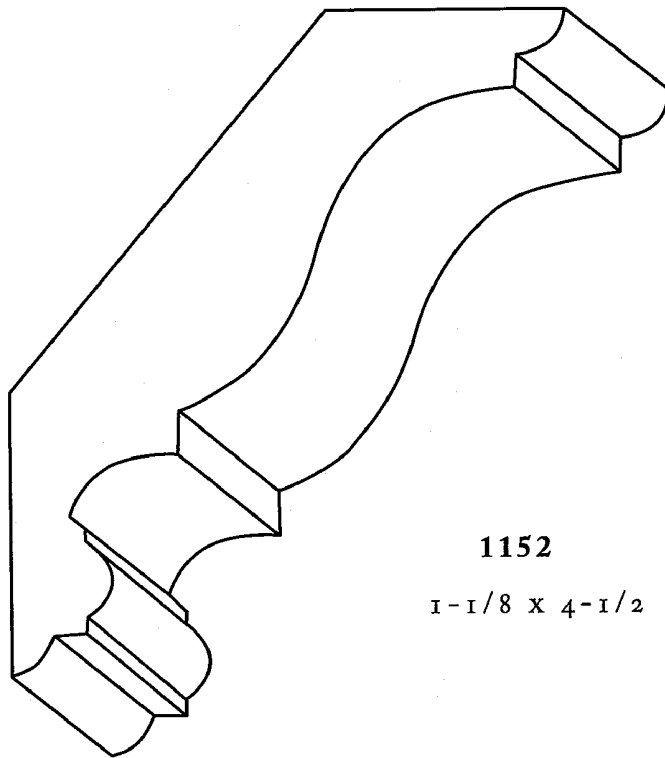

**1152**

1-1/8 X 4-1/2

CROWNS

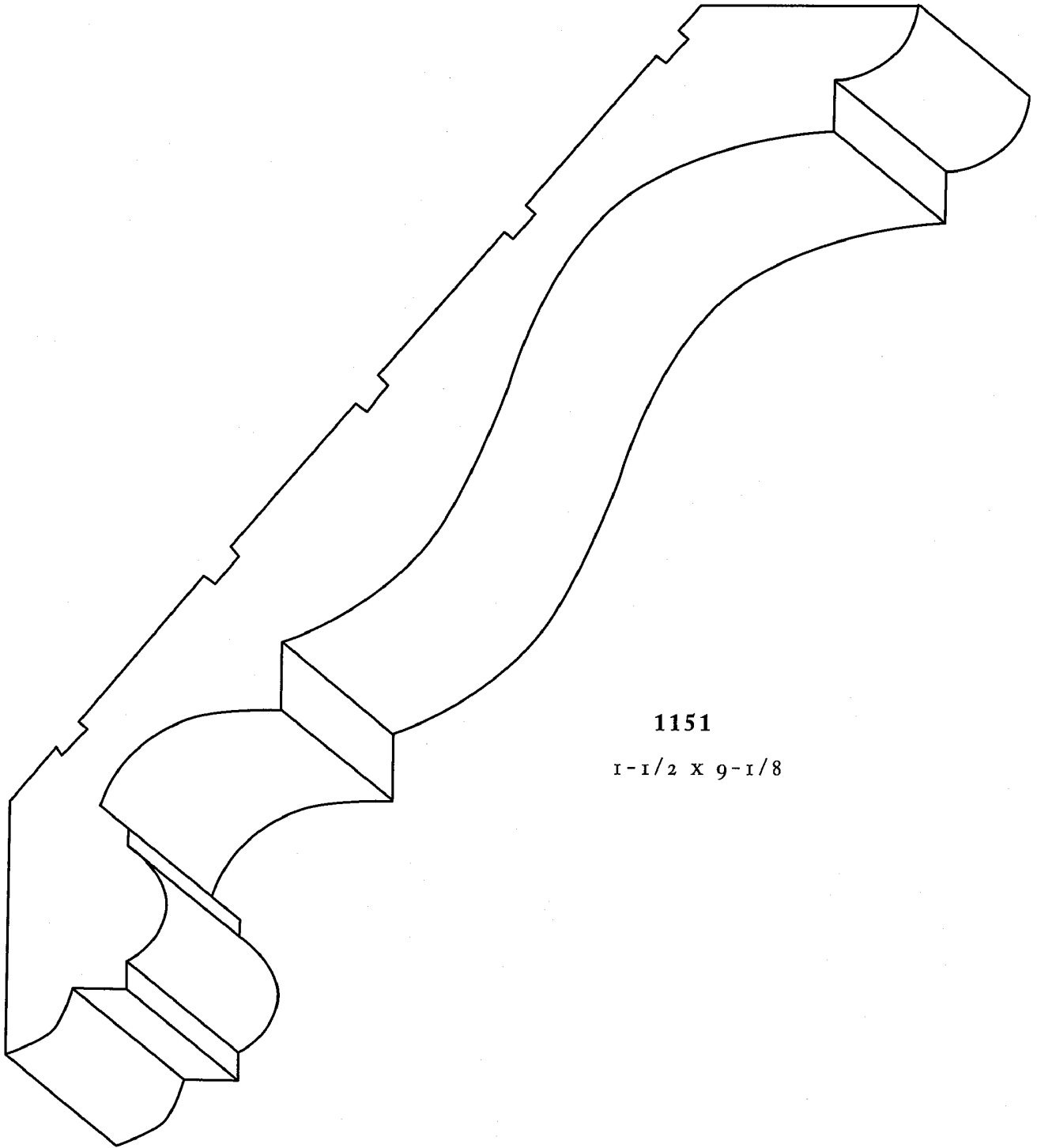

1151

1-1/2 X 9-1/8

CROWNS

1156

$3/4 \times 3-3/4$

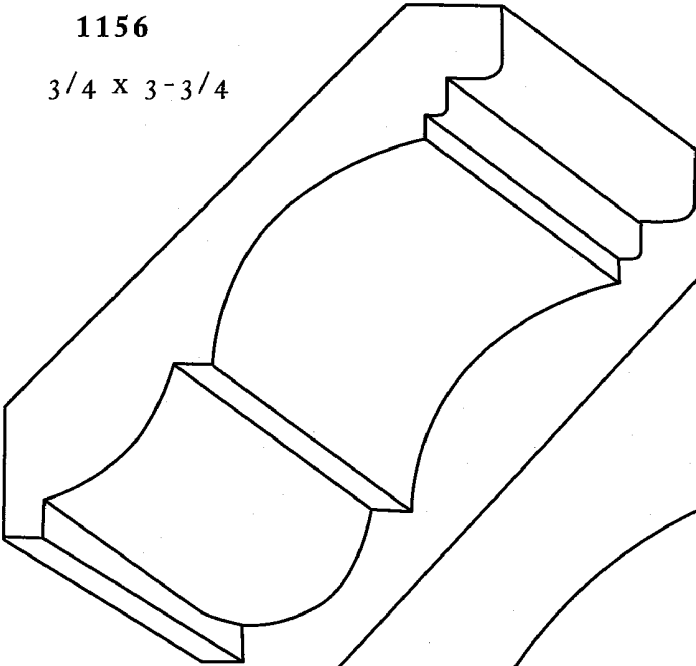

1158

$1-1/8 \times 7$

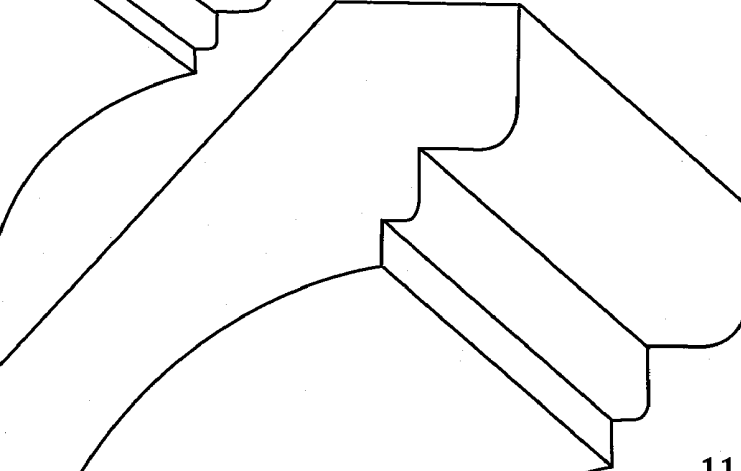

1157

$13/16 \times 4-3/4$

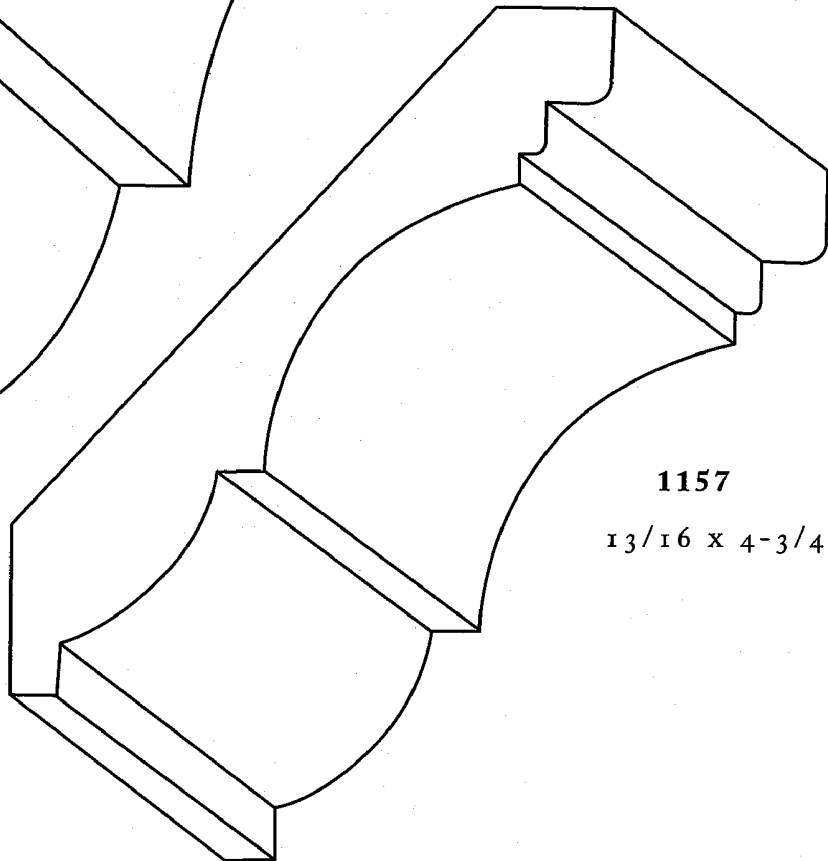

CASINGS

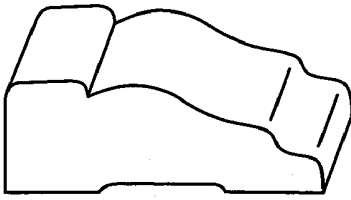

1202

9/16 x 1-5/8

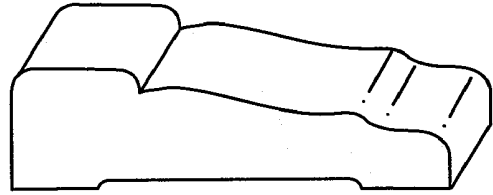

1203

5/8 x 2-1/4

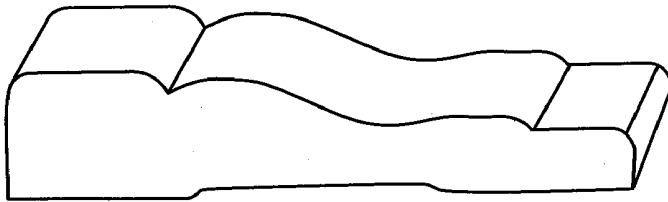

1204

5/8 x 3-1/4

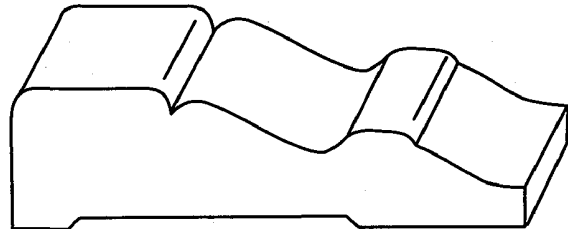

1205

3/4 x 2-5/8

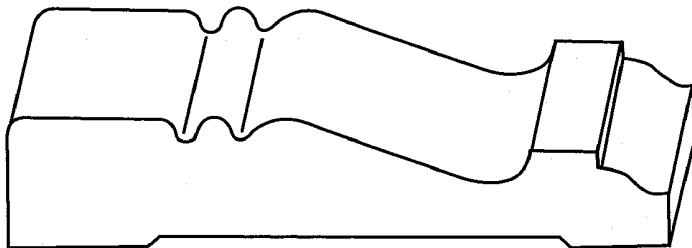

1206

11/16 x 3-7/16

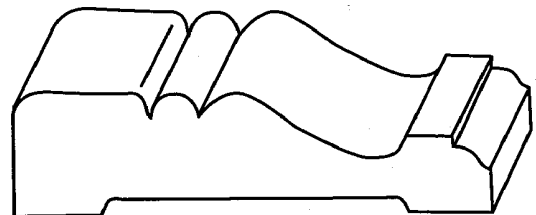

2206

11/16 x 2-7/16

CASINGS

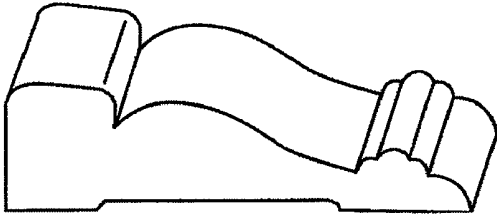

1207

11/16 x 2-7/16

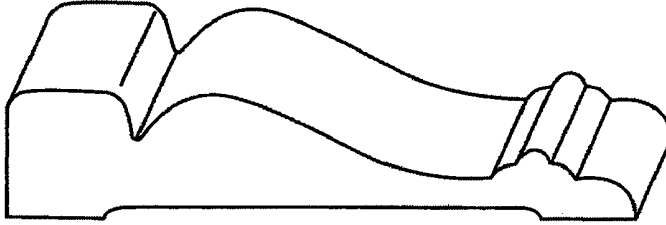

1208

11/16 x 3-1/4

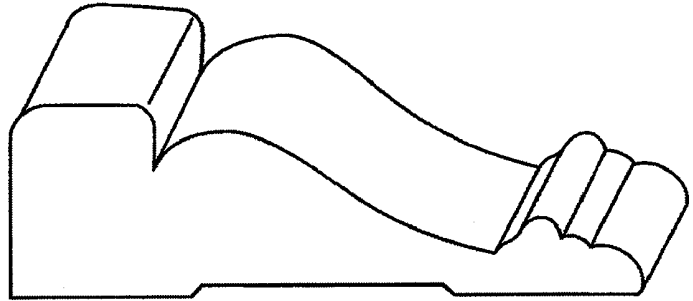

1209

1 x 3-1/4

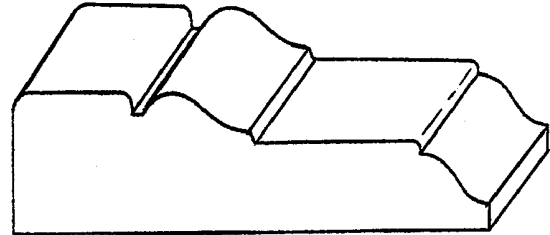

1216

3/4 x 2-1/2

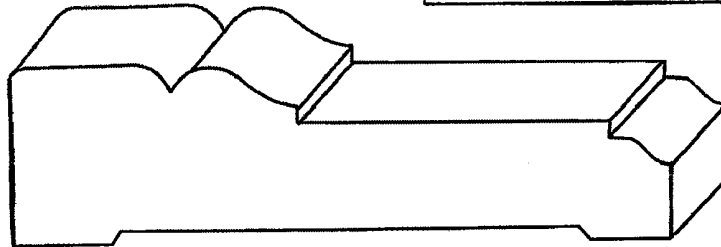

1210

7/8 x 3-7/16

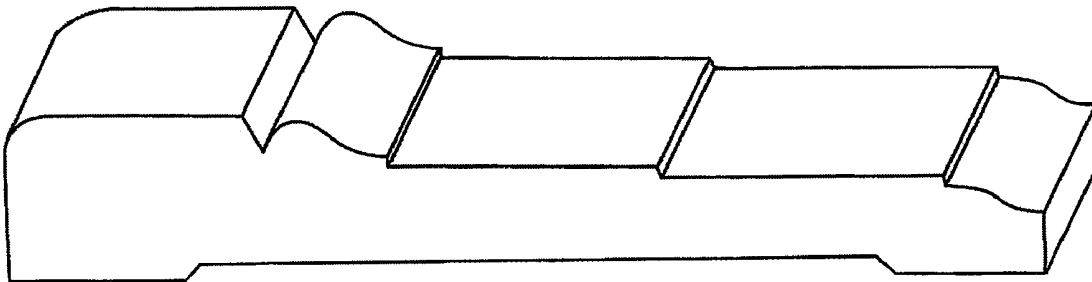

1211

7/8 x 5-7/16

CASINGS

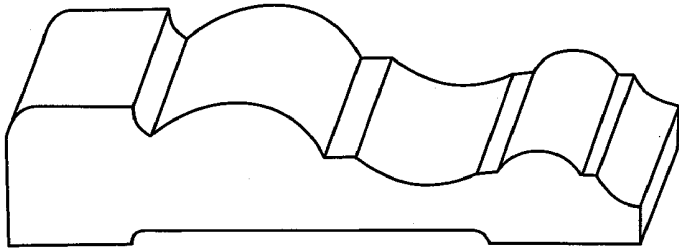

1212

3/4 x 3-1/4

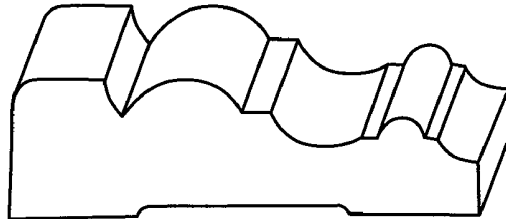

1213

3/4 x 2-7/16

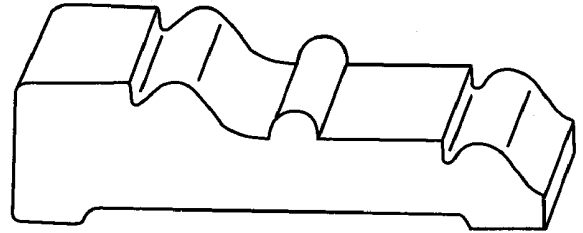

1220

3/4 x 2-3/4

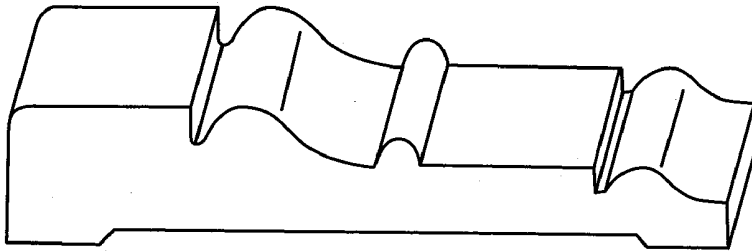

1221

3/4 x 3-3/4

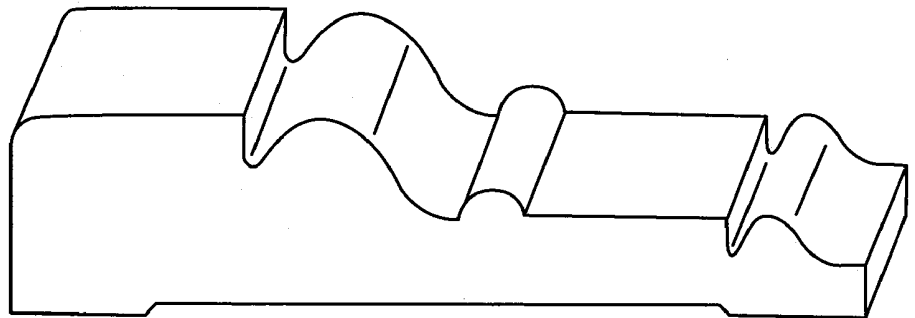

1222

1-1/16 x 4-7/16



CASINGS

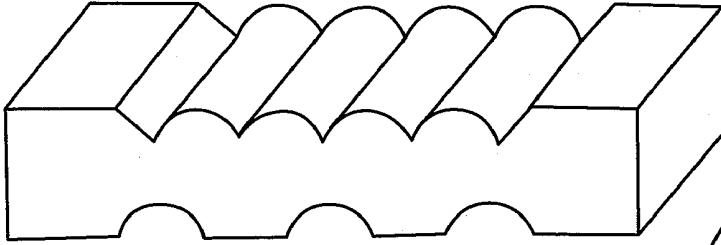

1229

11/16 X 3-1/4

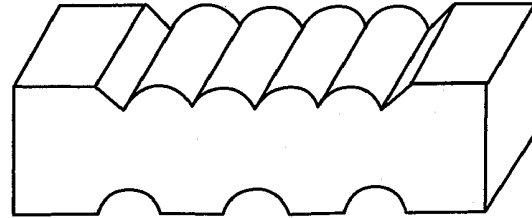

1219

11/16 X 2-7/16

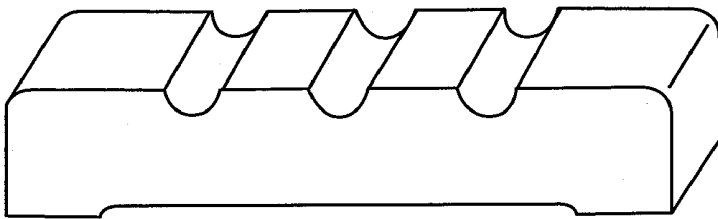

1226

11/16 X 3-7/16

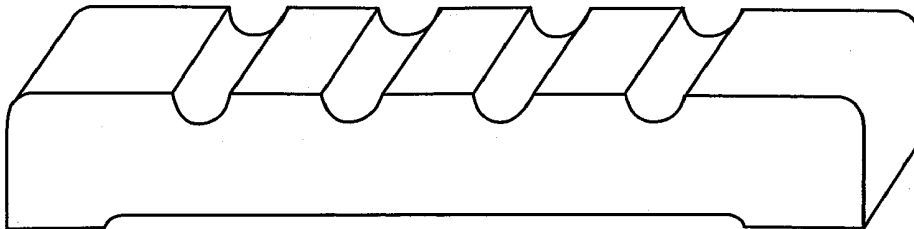

1227

11/16 X 4-7/16

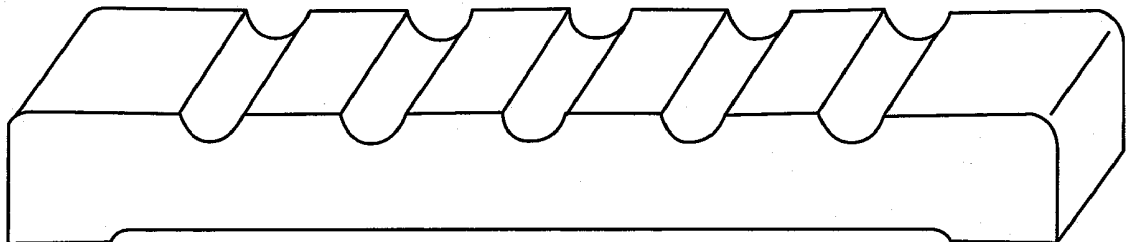

1228

11/16 X 5-7/16

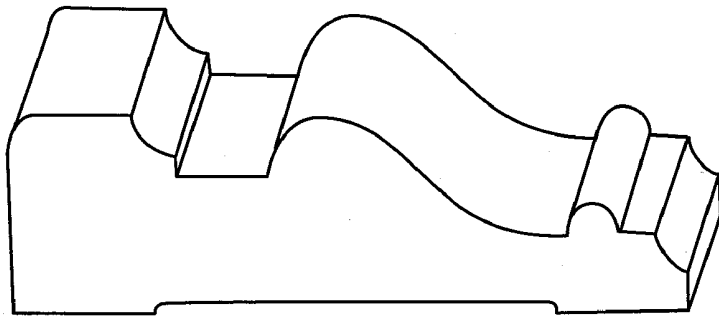

**1230**

1-1/16 x 3-1/2

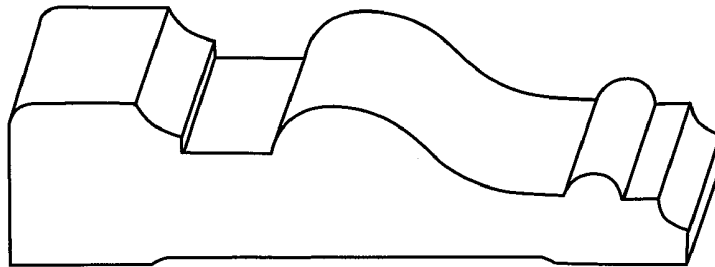

**1231**

7/8 x 3-1/2

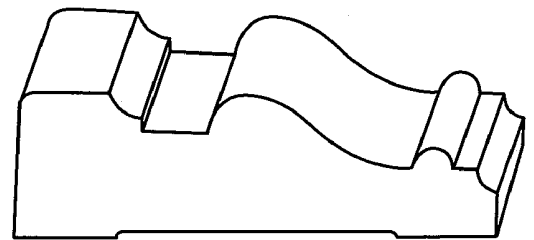

**1232**

3/4 x 2-1/2

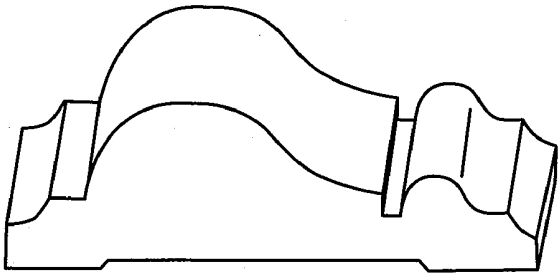

1233

7/8 x 2-3/4

SEE MATCHING PLINTH  
BLOCKS FOR THESE CASINGS  
ON PAGE 28

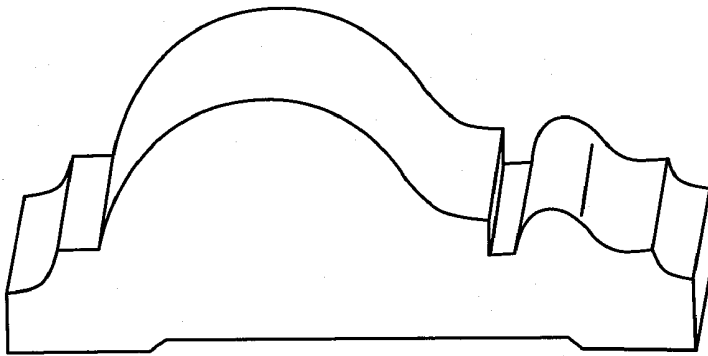

1234

1-3/8 x 3-9/16

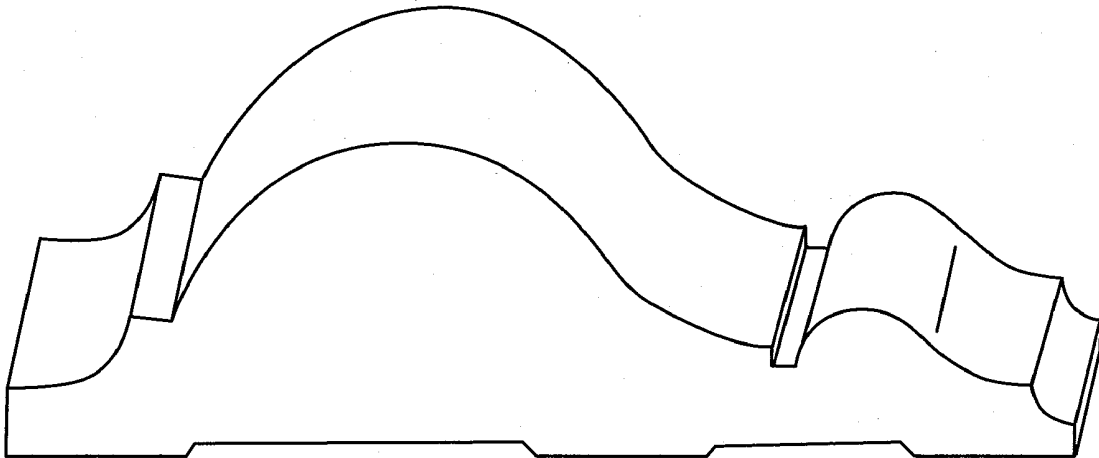

1235

1-5/8 x 5-1/2

MATCHING PLINTH BLOCKS

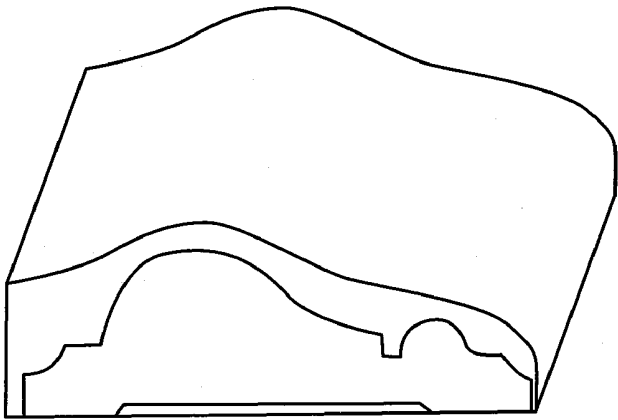

2233

1-1/16 X 2-3/4

(USE WITH 1233 CASING)

INSIDE PLINTH BLOCKS  
SHOWN HERE ARE THE  
OUTLINED CASING DETAILS  
TO BE USED

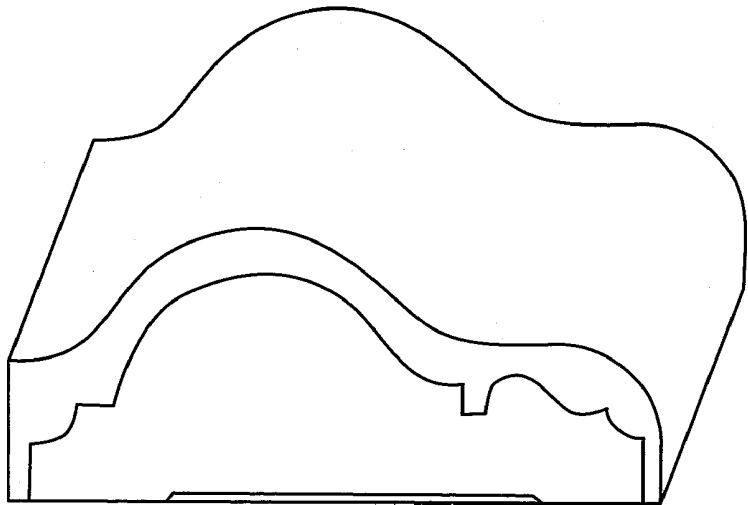

2234

1-5/8 X 3-3/4

(USE WITH 1234 CASING)

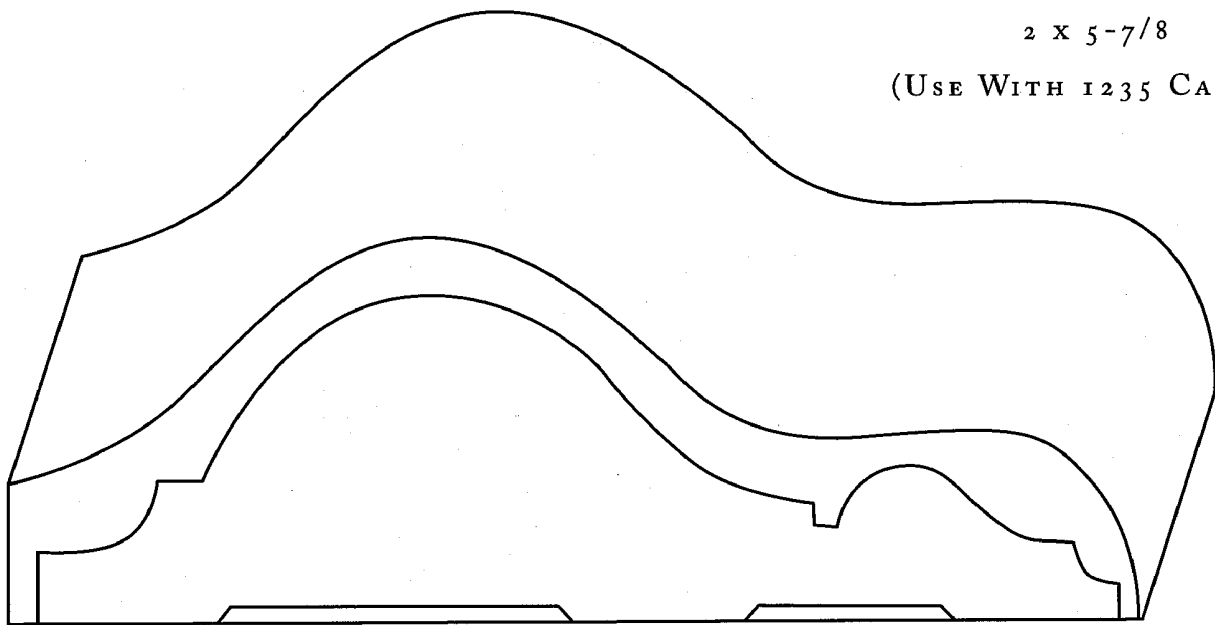

2235

2 X 5-7/8

(USE WITH 1235 CASING)

CASINGS

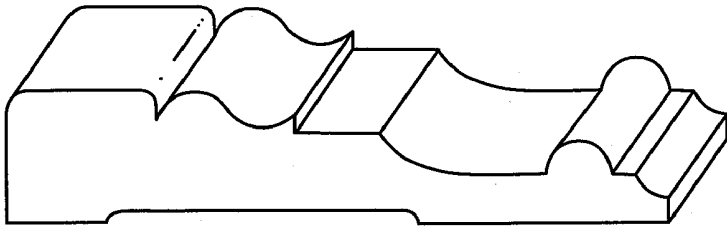

1237

$11/16 \times 3-7/16$

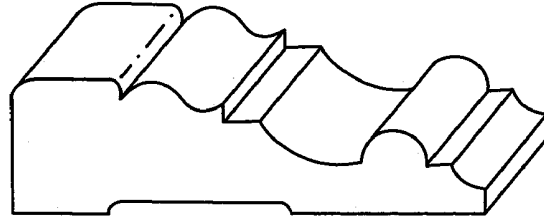

1236

$11/16 \times 2-7/16$

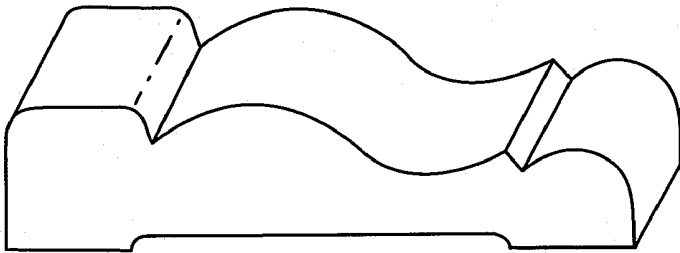

1239

$3/4 \times 3-1/4$

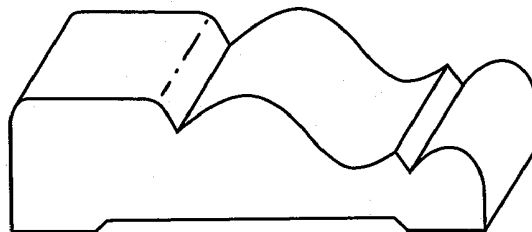

1238

$3/4 \times 2-7/16$

CASINGS

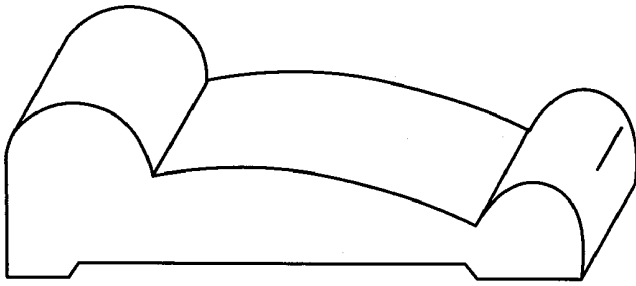

1250

7/8 x 3

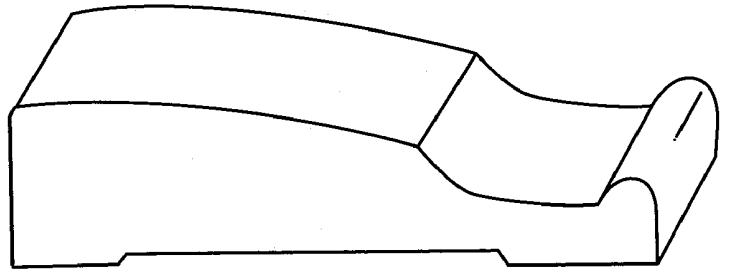

1251

7/8 x 3-3/8

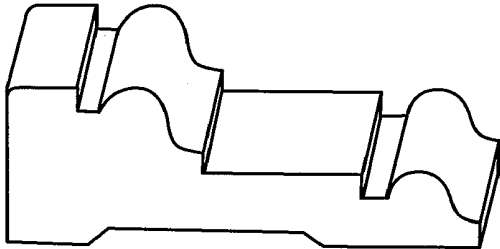

1257

13/16 x 2-7/16

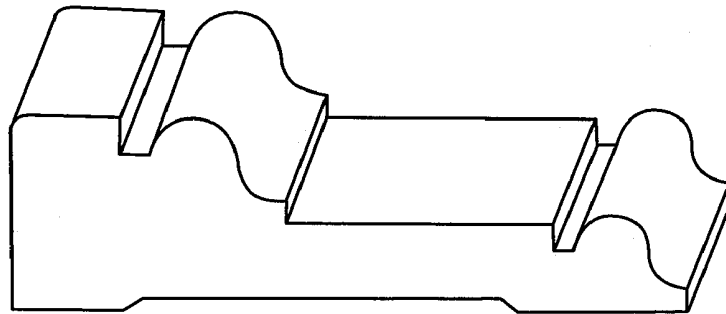

1258

1 x 3-1/2

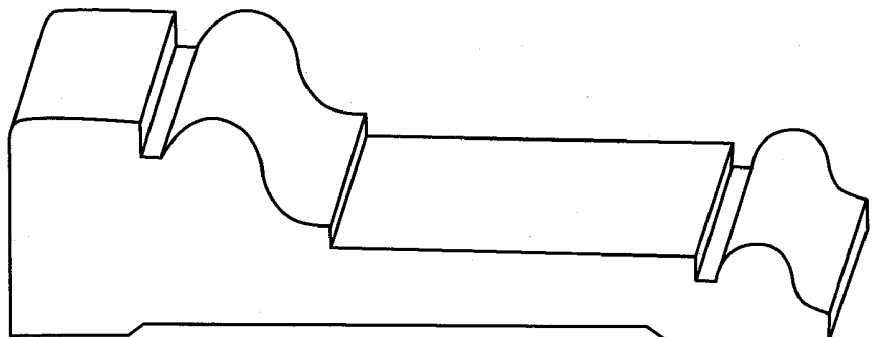

1259

1-1/8 x 4-1/4

CASINGS

1248  
7/8 x 3-3/8

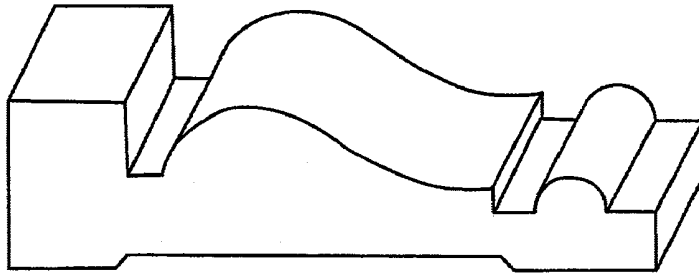

1249  
1-1/8 x 4-5/8

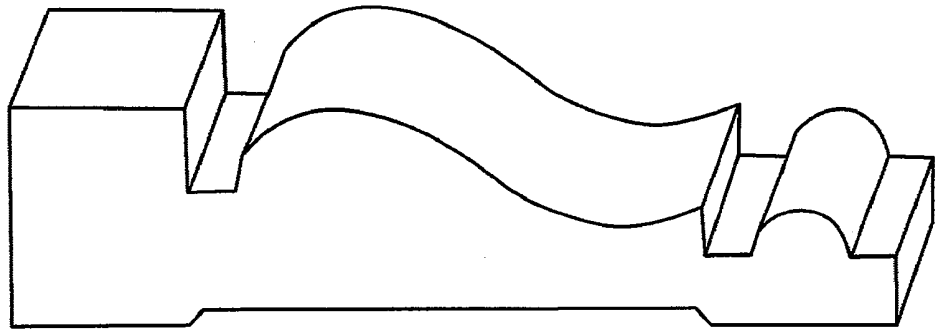

1267  
13/16 x 5-3/8

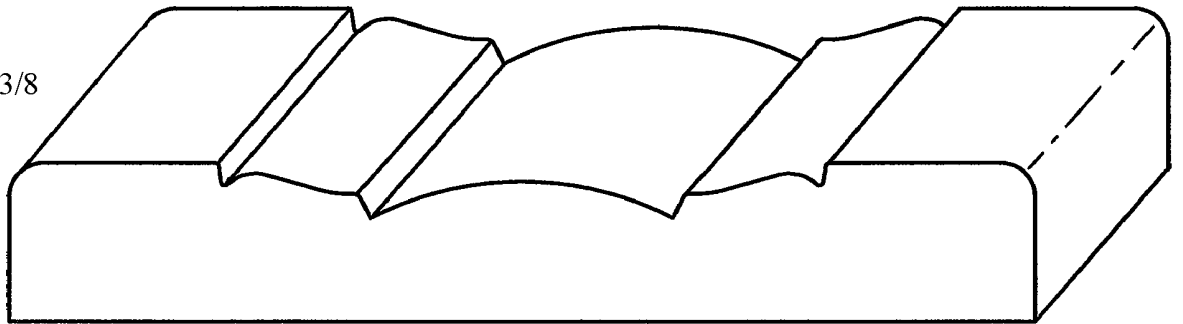

1268  
13/16 x 5-9/16

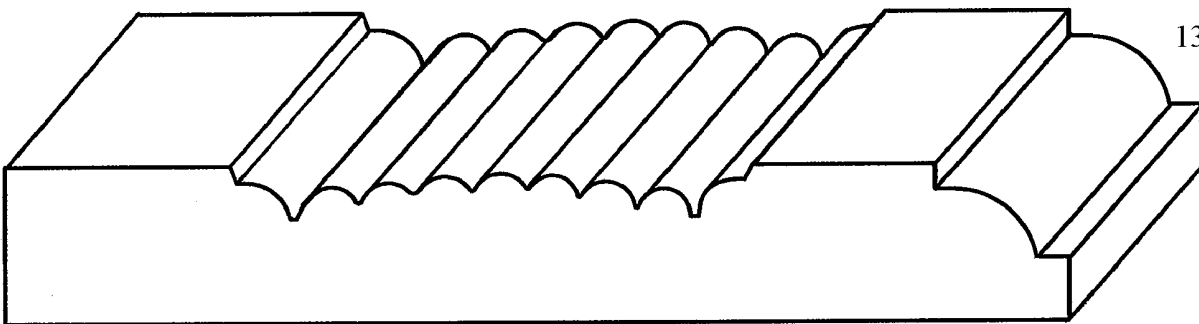

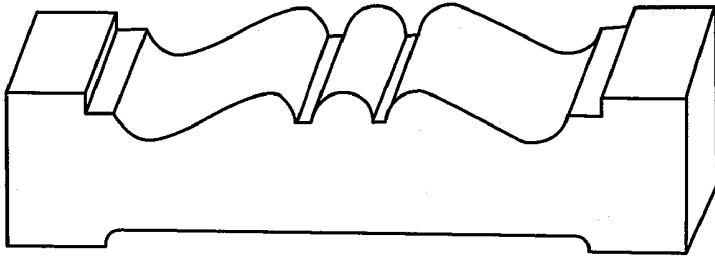

**1260**

$3/4 \times 3-1/2$

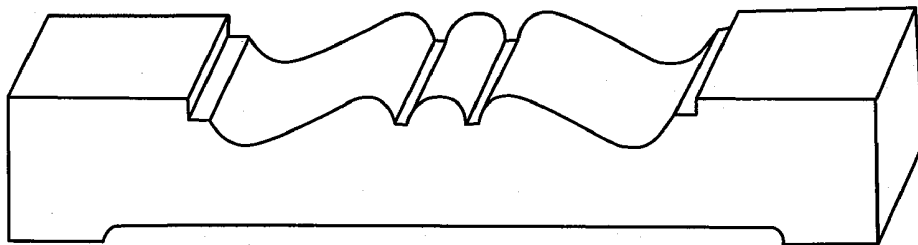

**1261**

$3/4 \times 4-1/2$

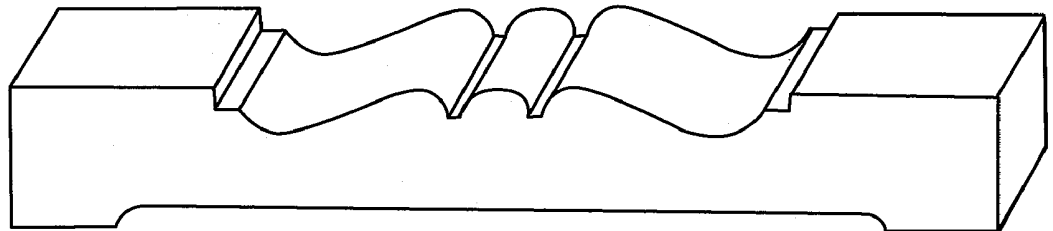

**1262**

$3/4 \times 5-1/8$



CASINGS

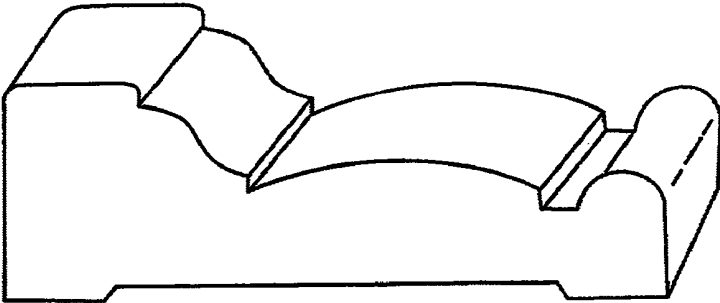

1265

1-1/8 x 3-1/2

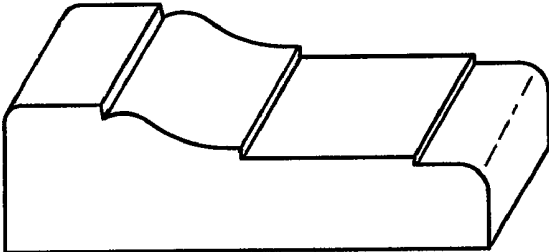

1255

3/4 x 2-1/2

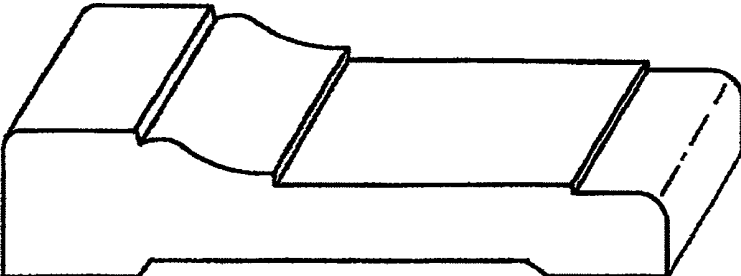

1256

3/4 x 3-1/2

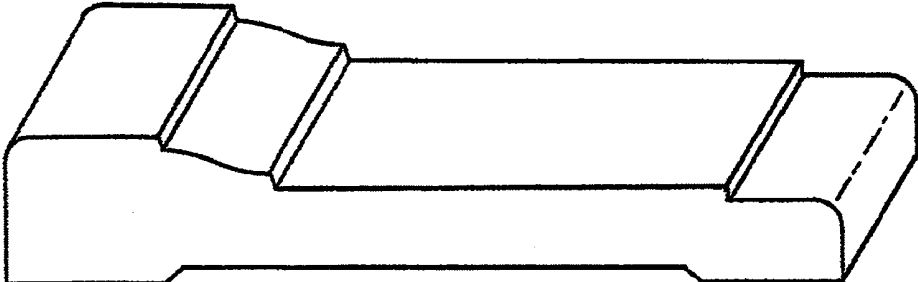

1254

3/4 x 4-7/16

APRONS

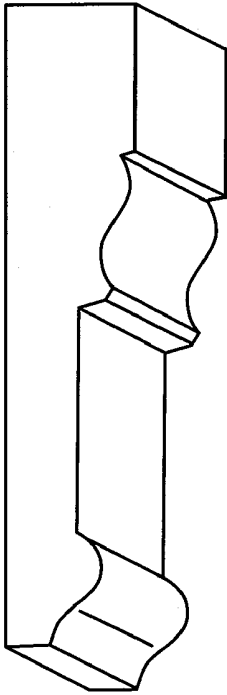

1244

11/16 x 3-5/16

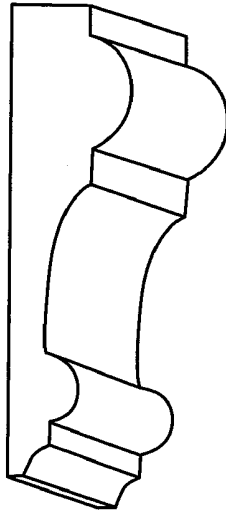

1247

11/16 x 2-7/16

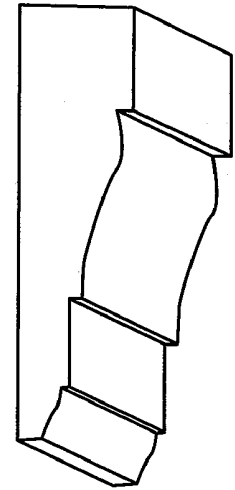

1245

5/8 x 2-1/4

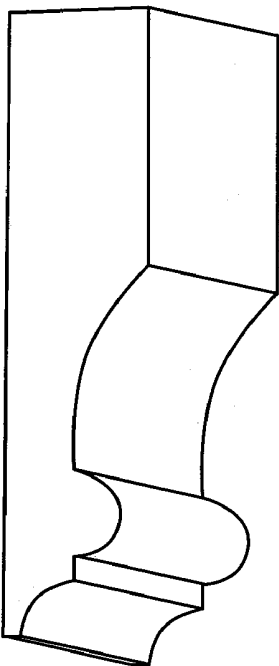

1241

13/16 x 3-1/4

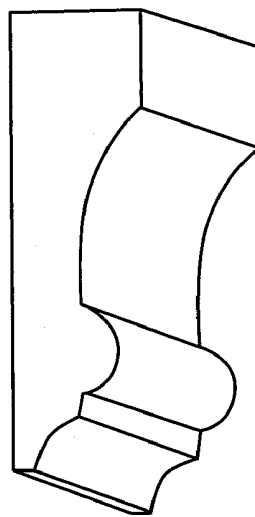

1240

11/16 x 2-3/8

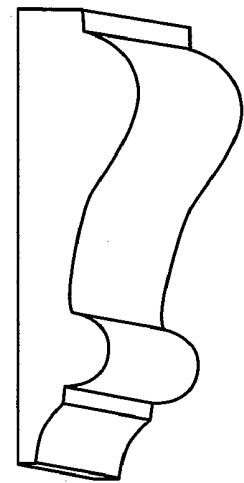

1246

11/16 x 2-3/8

APRONS

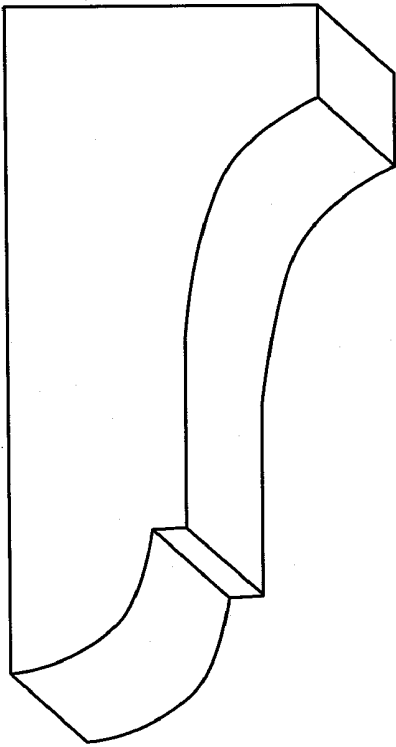

1243

1-5/8 x 3-7/16

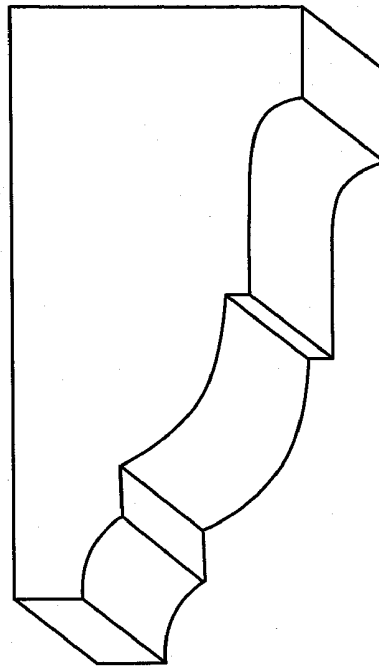

1242

1-1/2 x 3-1/16

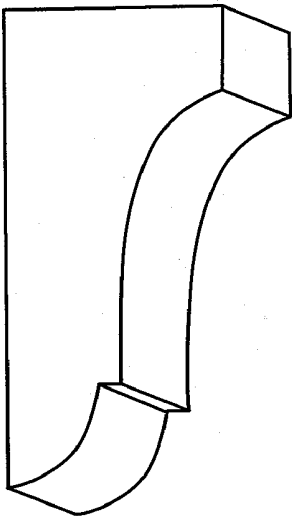

1263

1-1/8 x 2-1/2

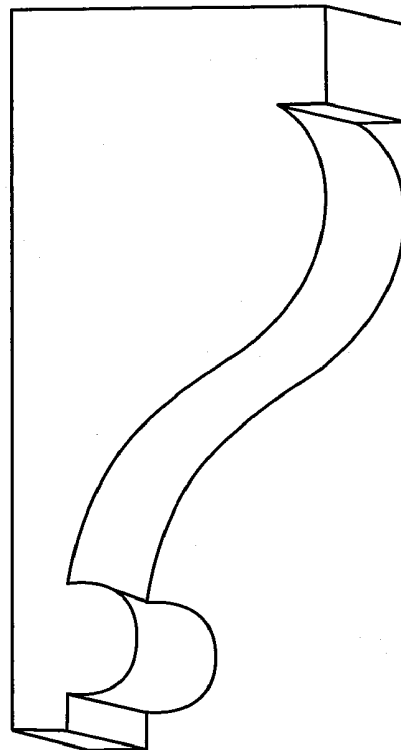

1264

1-5/8 x 3-3/4

PLINTH & CORNER BLOCKS

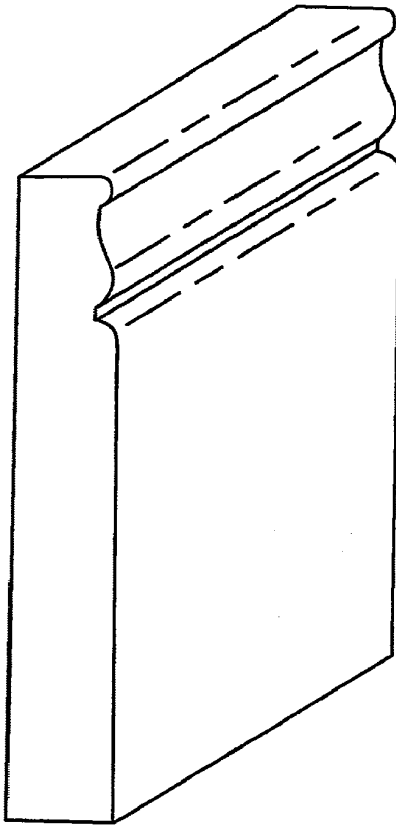

234 - 1-1/8 x 8

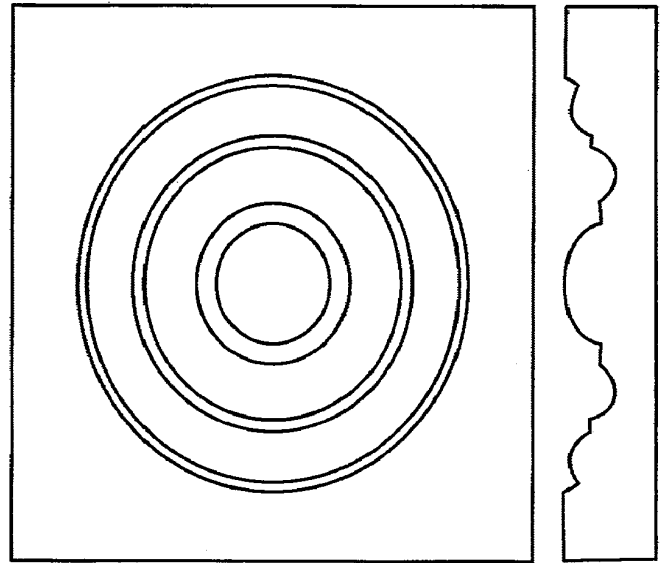

162 - 1 x 2-3/4

163 - 1 x 3-3/4

164 - 1 x 4-3/4

165 - 1 x 5-1/2

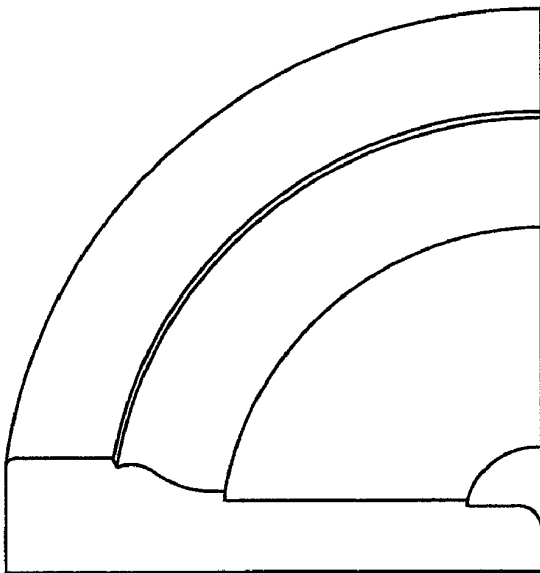

1256 CASING RADIUS CORNERS

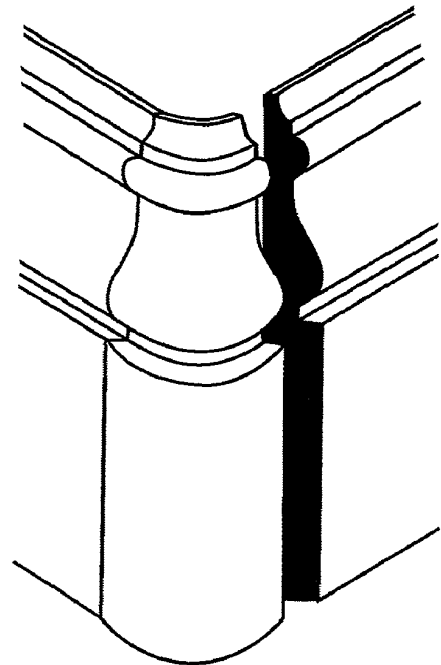

BASE RADIUS CORNERS

BASES

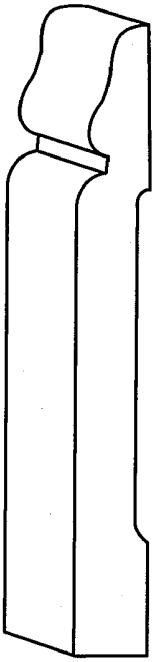

1307

$3/8 \times 3-1/4$

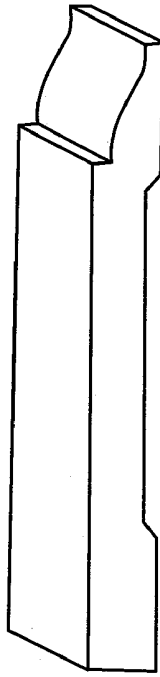

1303

$3/8 \times 3-1/4$

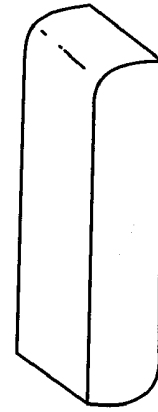

1300

$3/8 \times 1-3/4$

1301

$3/8 \times 2-1/4$

1302

$3/8 \times 3-1/4$

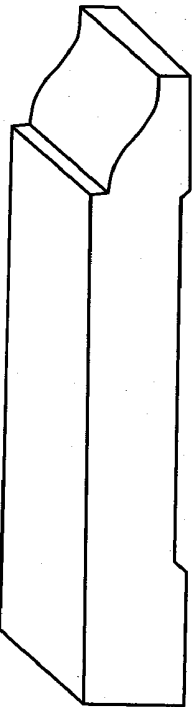

1304

$9/16 \times 3-1/4$

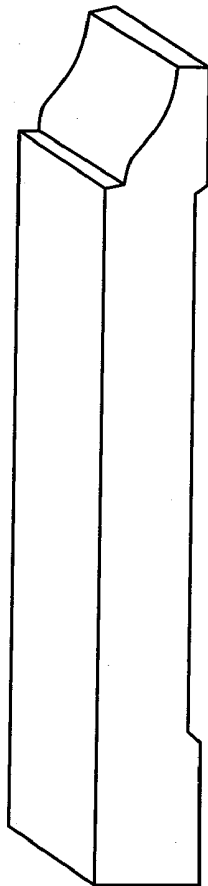

1305

$9/16 \times 4-1/4$

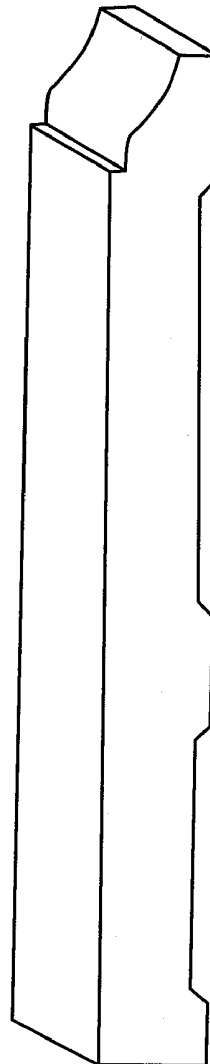

1306

$9/16 \times 5-1/4$

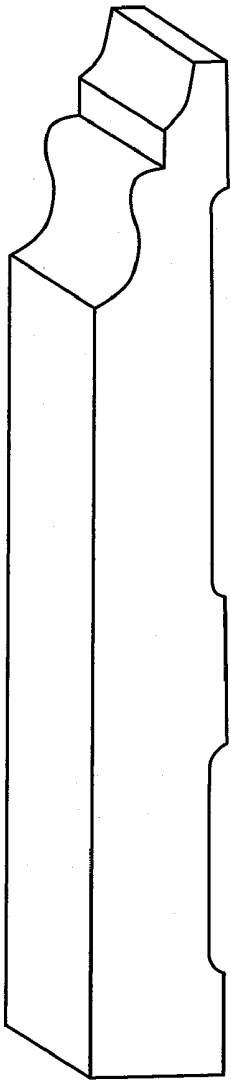

**1311**

$11/16 \times 5-1/4$

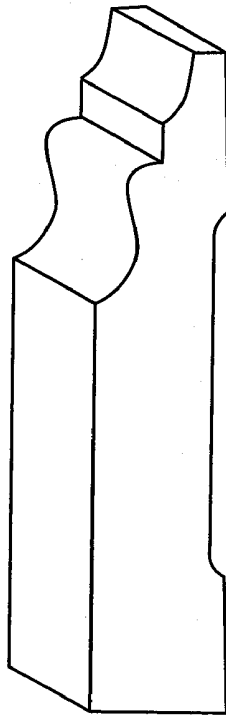

**1309**

$11/16 \times 3-7/16$

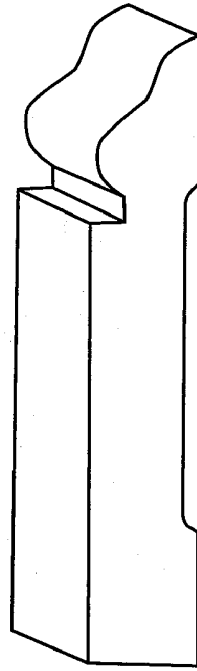

**1308**

$9/16 \times 3-1/4$

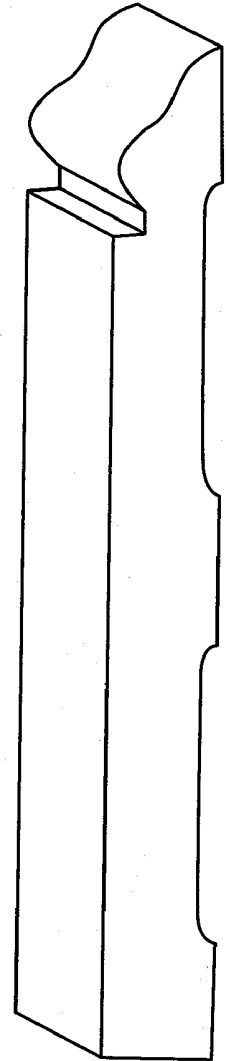

**1310**

$9/16 \times 5-1/4$

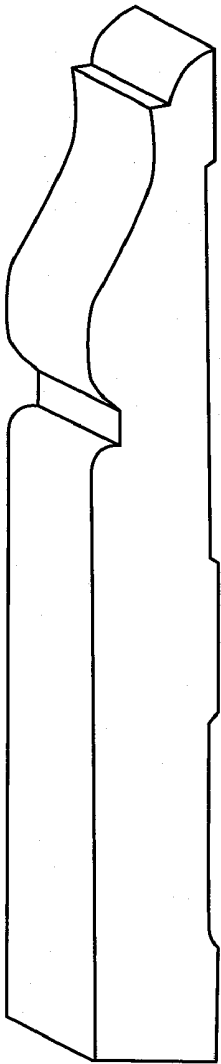

**1312**  
11/16 x 5-1/4

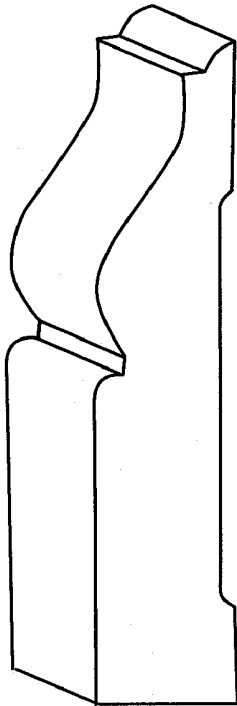

**2312**  
11/16 x 3-7/16

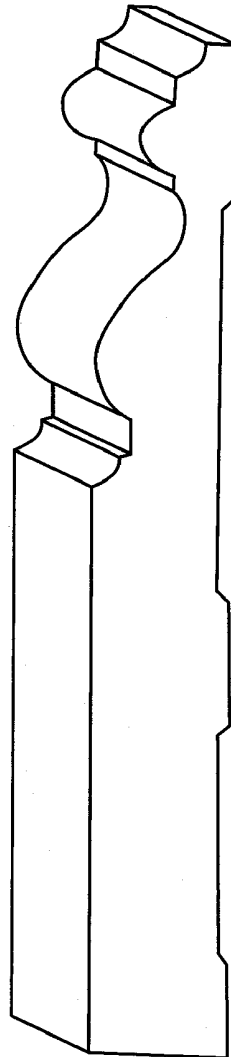

**1337**  
11/16 x 5-1/4

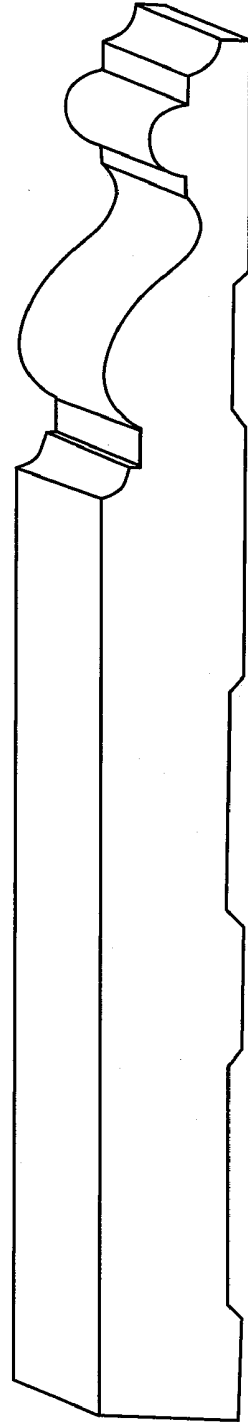

**1338**  
11/16 x 7-3/16

BASES

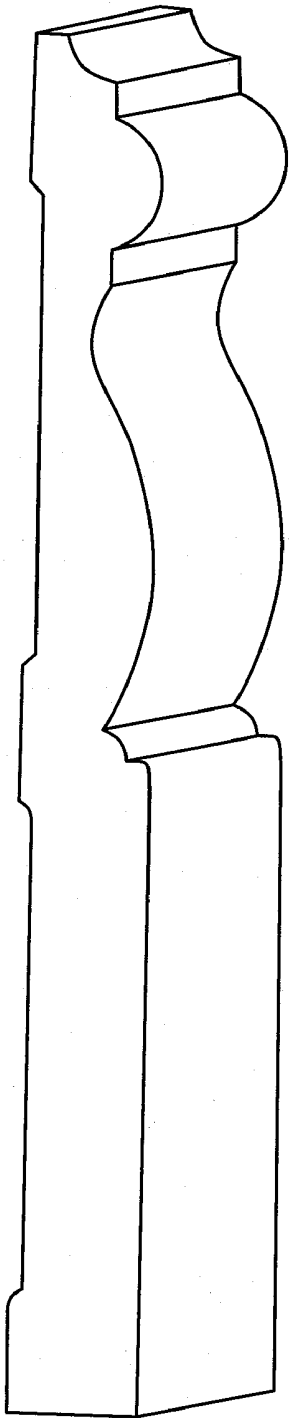

**1316**

11/16 x 7-1/8

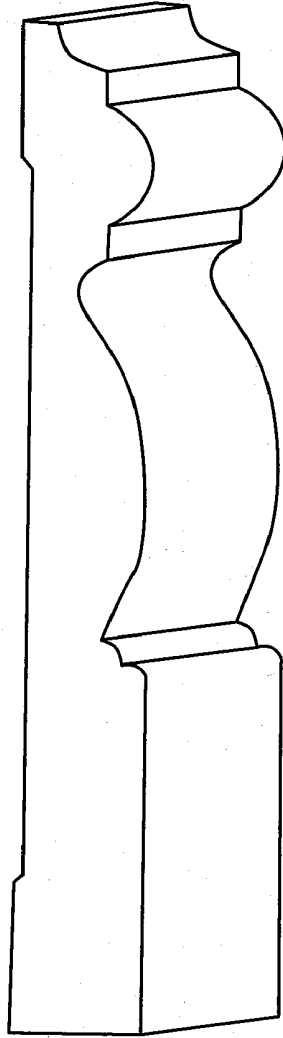

**1315**

11/16 x 5-1/4

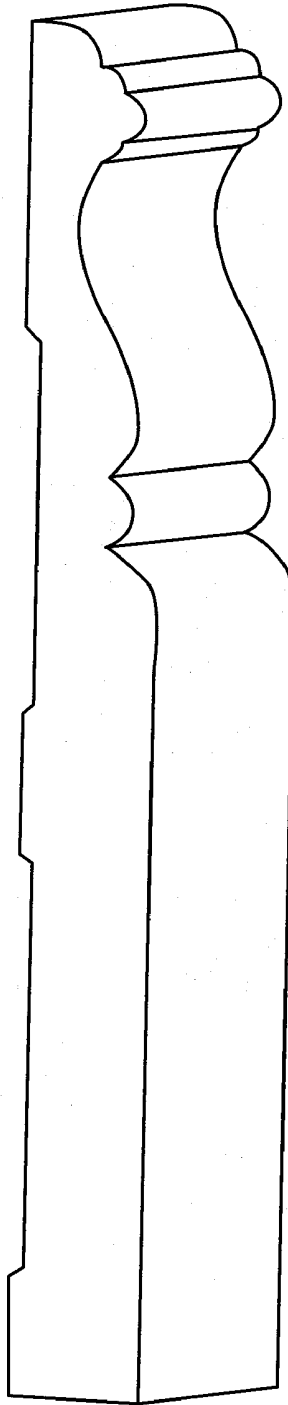

**1318**

11/16 x 7-1/8

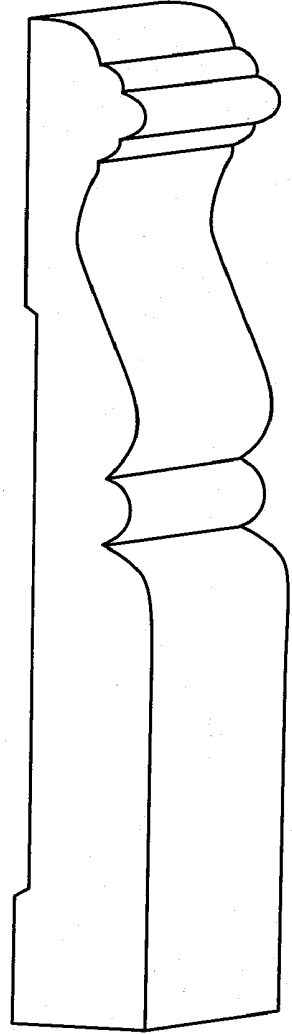

**1317**

11/16 x 5-1/4



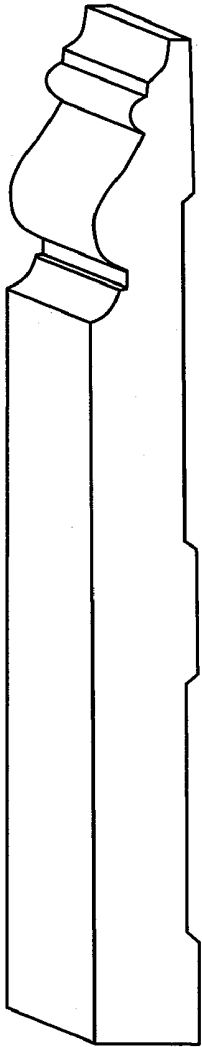

**1336**  
9/16 x 5-1/4

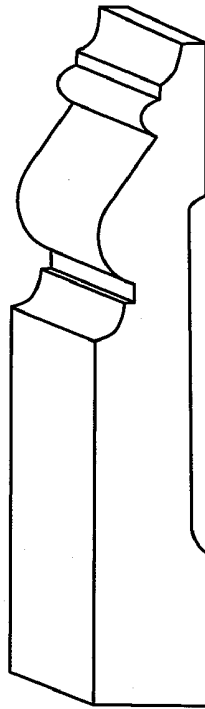

**1334**  
9/16 x 3-7/16

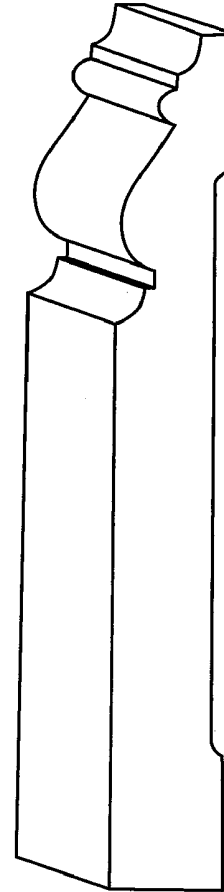

**1335**  
9/16 x 4-7/16

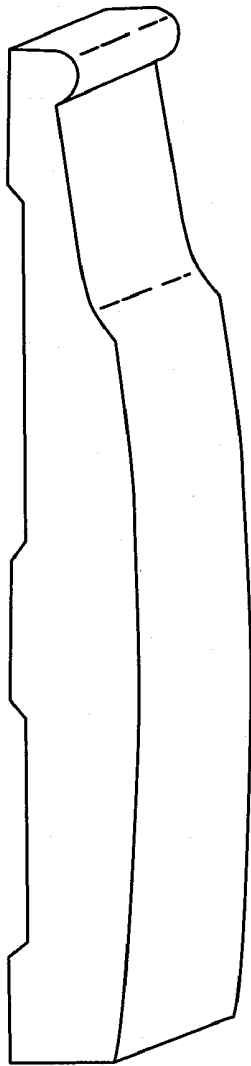

1360

3/4 X 5-1/4

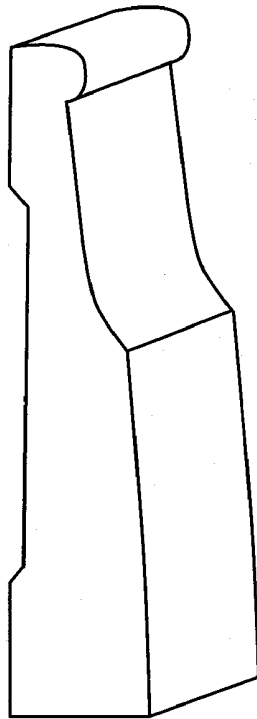

1359

11/16 X 3-1/2

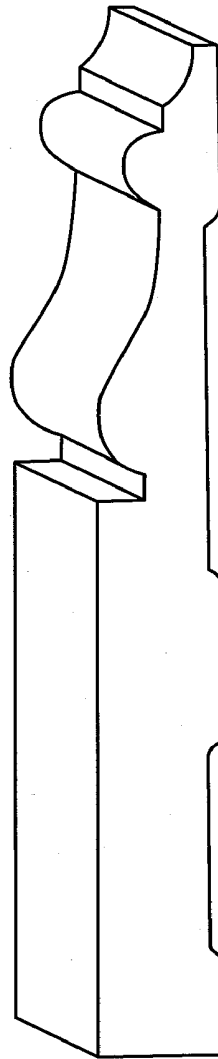

1313

11/16 X 5-1/4

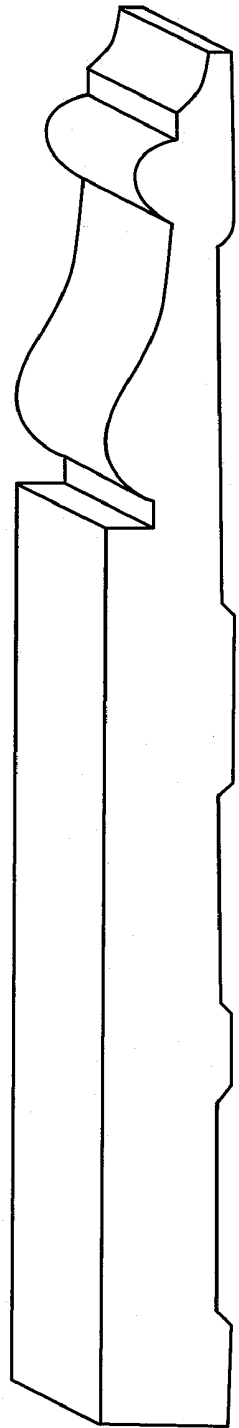

1314

11/16 X 7-1/8

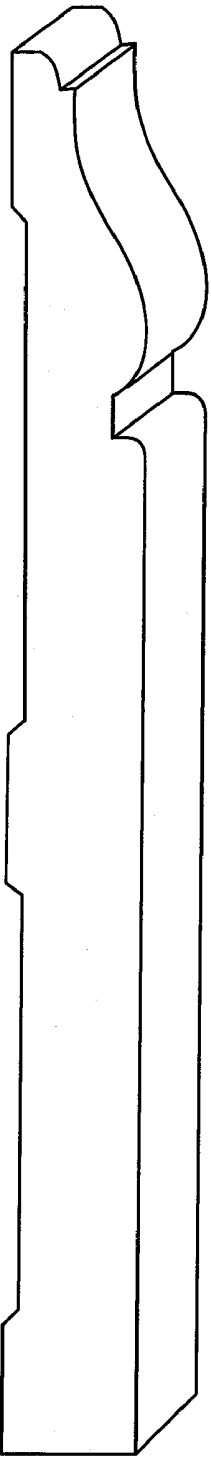

1343

11/16 X 7-1/4

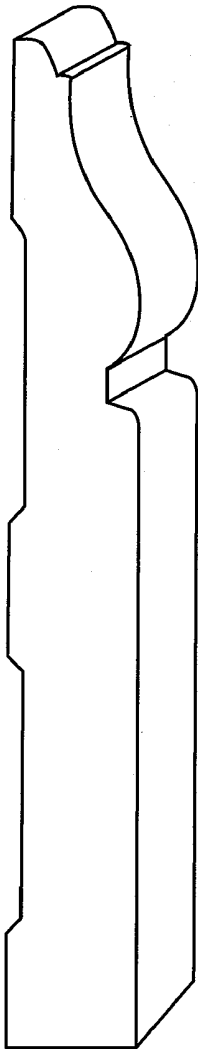

1342

11/16 X 5-1/4

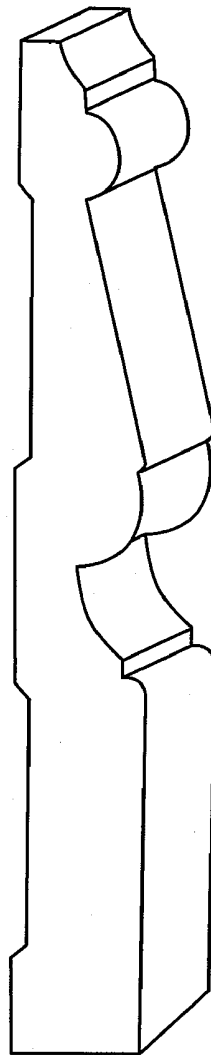

1340

11/16 X 5-1/4

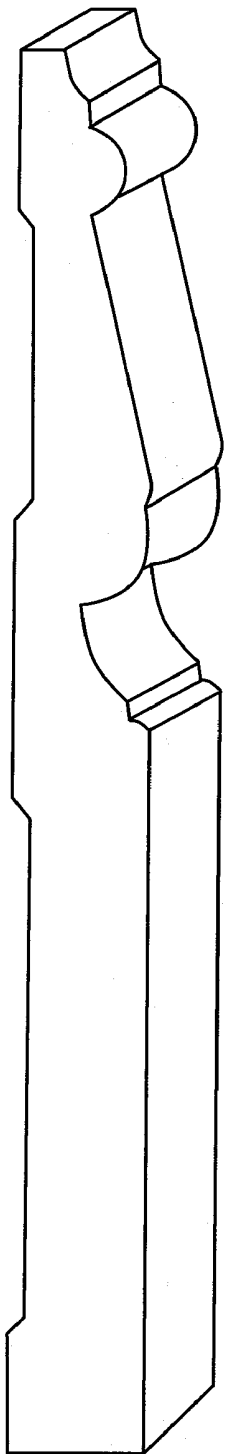

1341

11/16 X 7-1/4

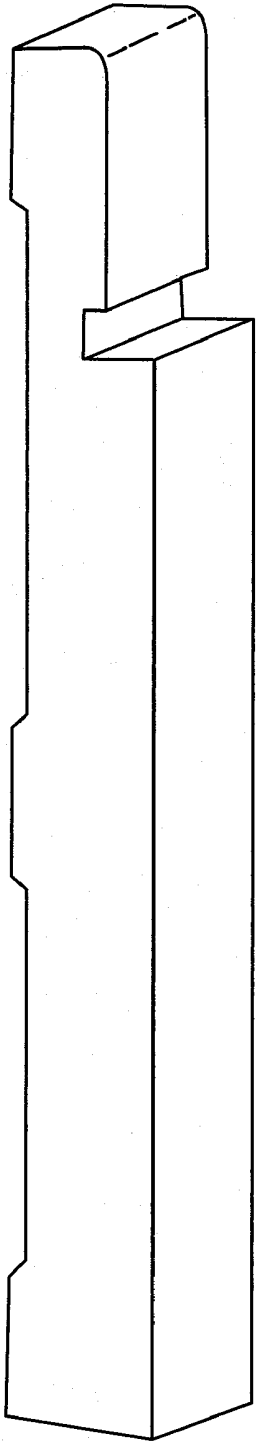

1364

11/16 X 7-1/4

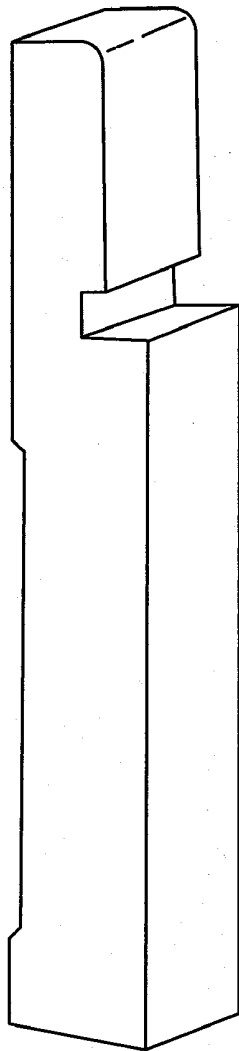

1363

11/16 X 5-1/4

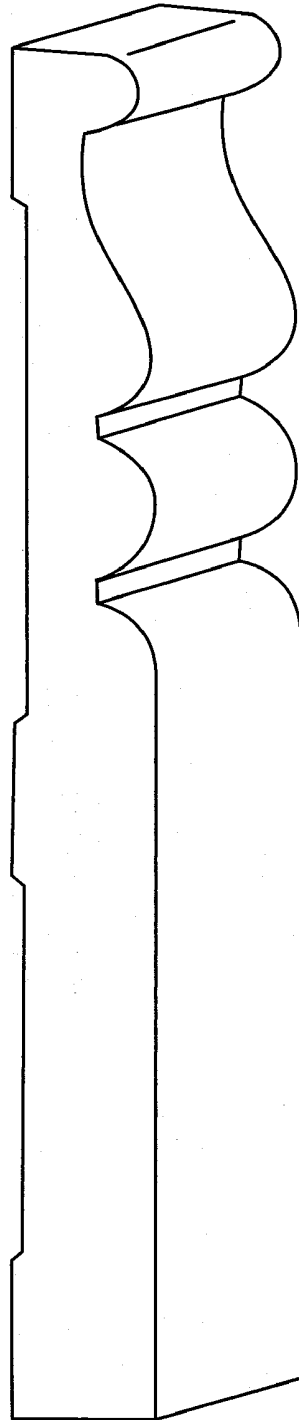

1362

11/16 X 7-1/8

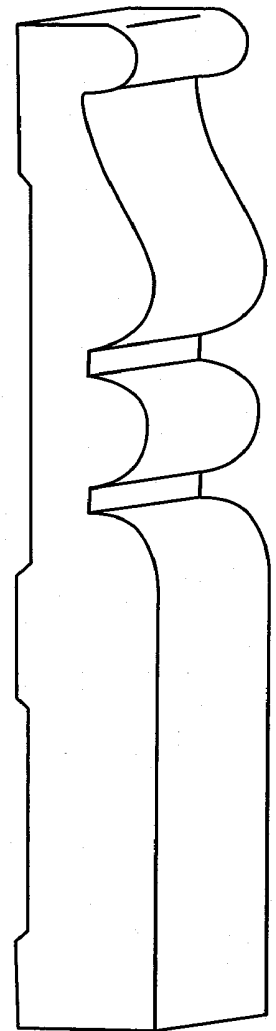

1361

11/16 X 5-1/4

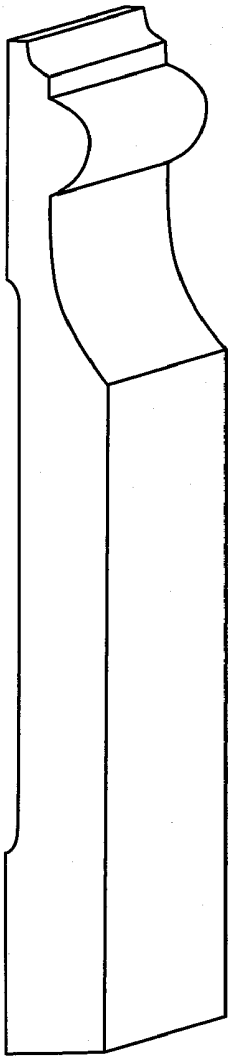

1358

9/16 x 5-1/4

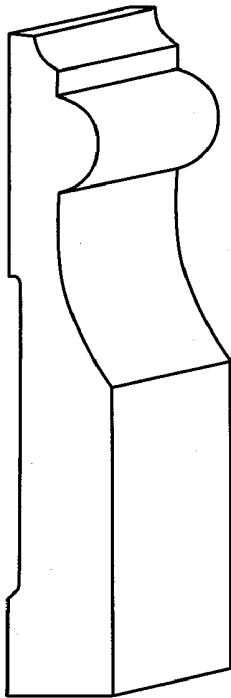

1357

9/16 x 3-7/16



1355

11/16 x 3-1/2

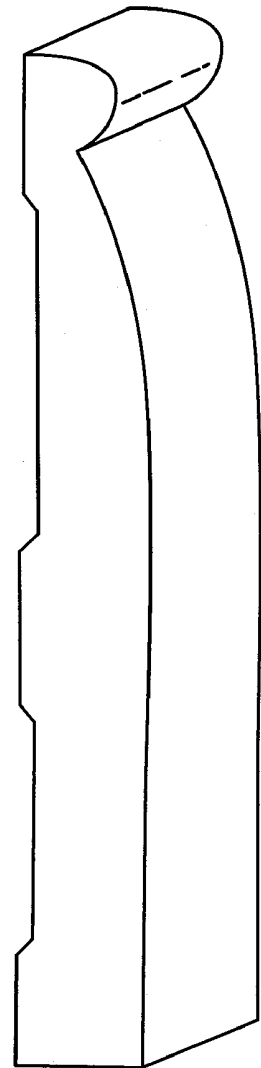

1356

11/16 x 5-1/4

BASE CAPS

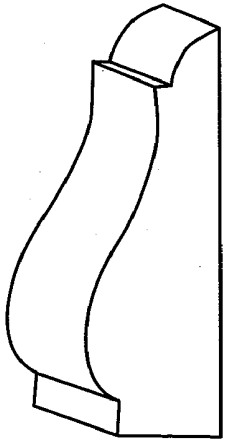

1365

11/16 X 2-1/8

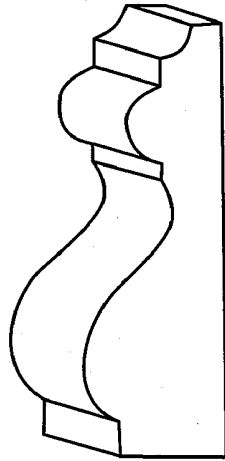

1366

11/16 X 2-1/4

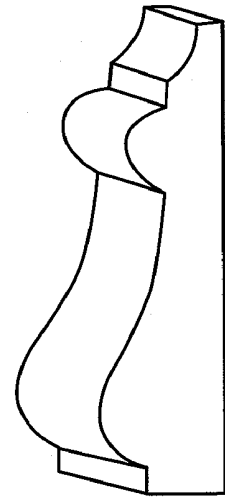

1367

11/16 X 2-7/16

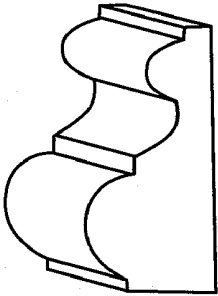

1353

11/16 X 1-3/8

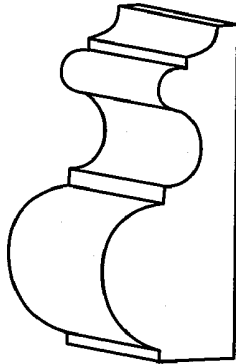

1354

3/4 X 1-3/4

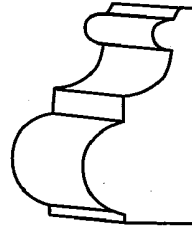

1368

1/2 X 1-1/8

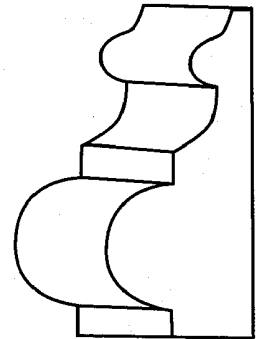

1369

3/4 X 1-3/4

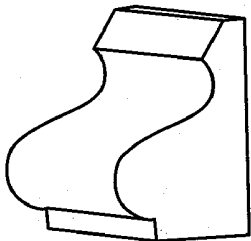

1350

11/16 X 1-1/8

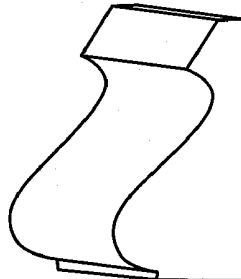

1351

11/16 X 1-3/8

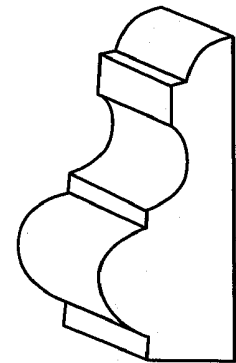

1352

3/4 X 1-11/16

BED & COVE MOULDS

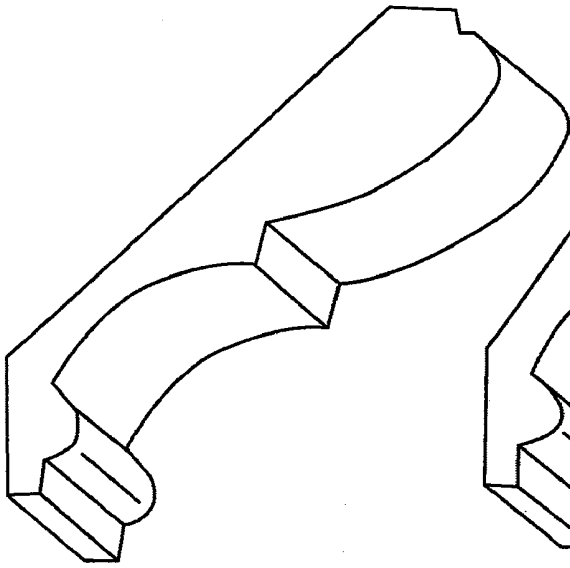

1411

11/16 X 3-7/16

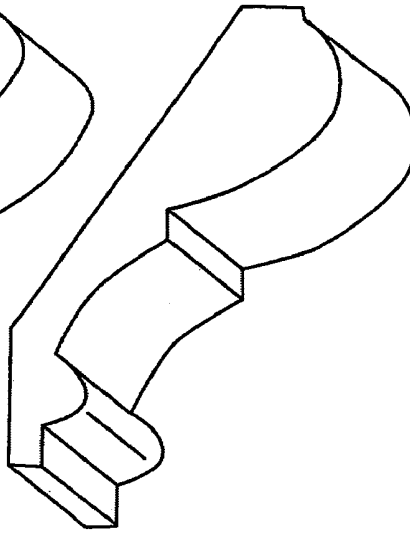

1410

11/16 X 2-13/16

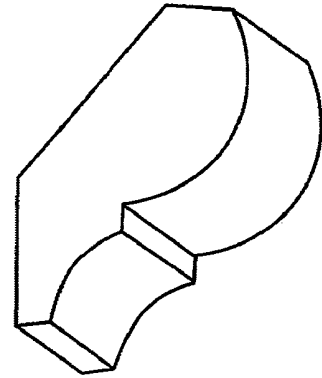

1409

11/16 X 2

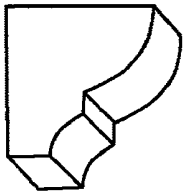

1405

3/4 X 3/4

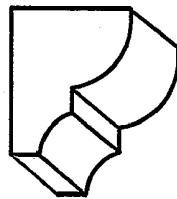

1416

5/8 X 3/4

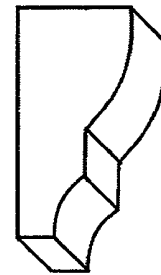

1415

5/8 X 1 1/4

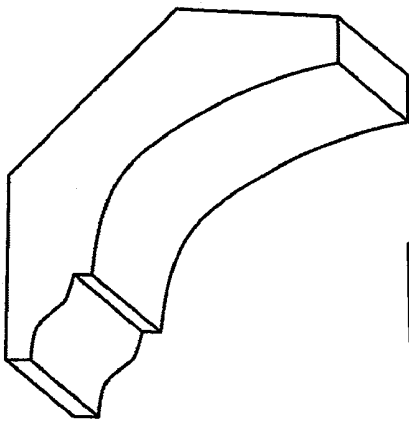

1404

3/4 X 2-1/2

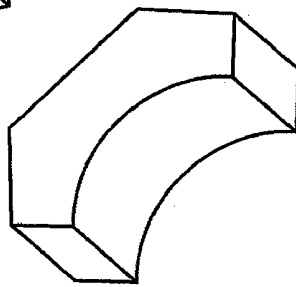

1402

5/8 X 1-5/8

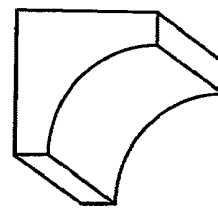

1401

3/4 X 3/4

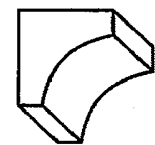

1400

1/2 X 1/2

OUTSIDE CORNERS & DOOR STOPS

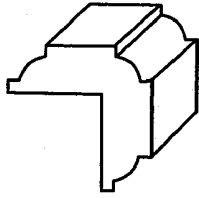

**1406**

$3/4 \times 3/4$

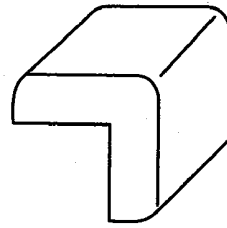

**1407**

$3/4 \times 3/4$

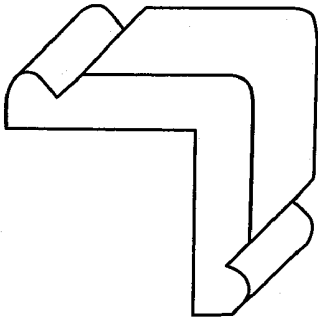

**1412**

$1-1/4 \times 1-1/4$

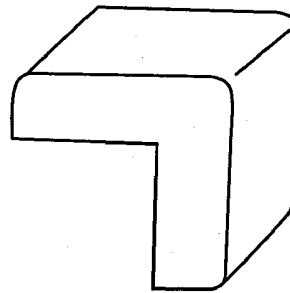

**1408**

$1-1/8 \times 1-1/8$

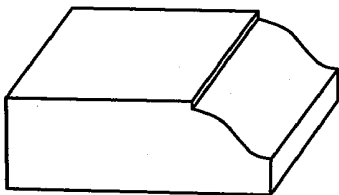

**1912**

$1/2 \times 1-3/8$

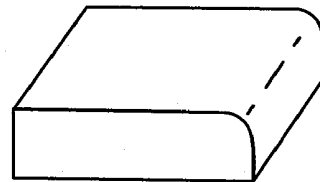

**1911**

$3/8 \times 1-1/4$



CHAIR RAILS

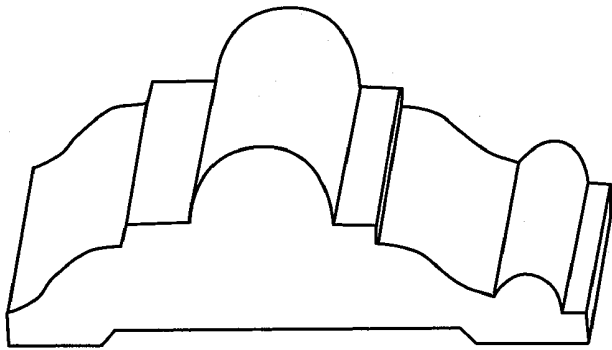

1505

1-1/16 X 3

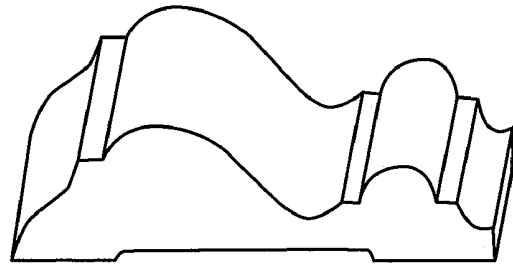

1502

3/4 X 2-1/2

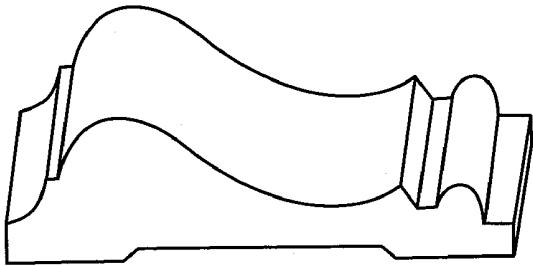

1503

3/4 X 2-5/8

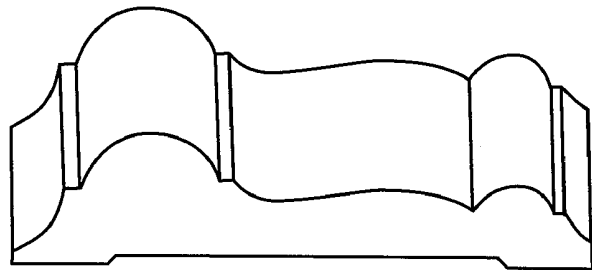

1506

11/16 X 3

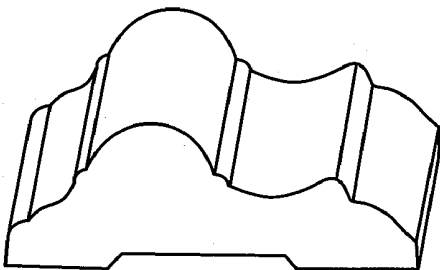

1501

3/4 X 2-1/8

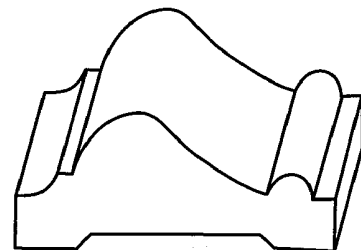

1500

3/4 X 1-5/8

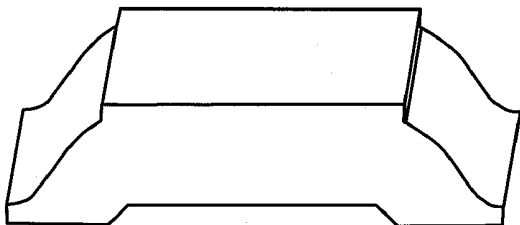

1504

5/8 X 2-9/16

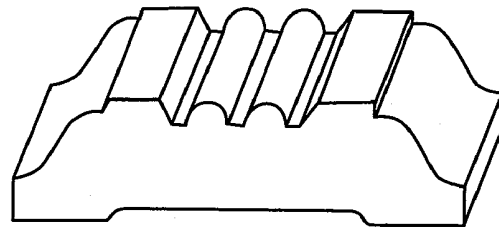

1507

5/8 X 2-5/16

BOLECTIONS

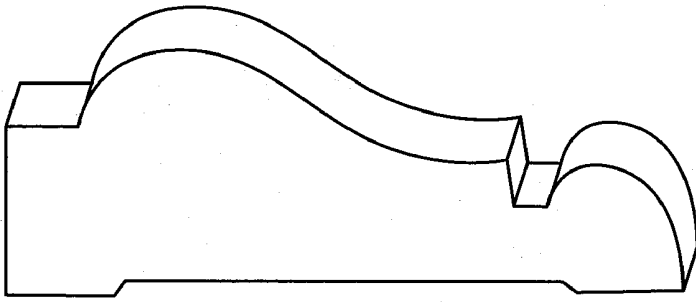

1513

1-1/4 X 3-1/2

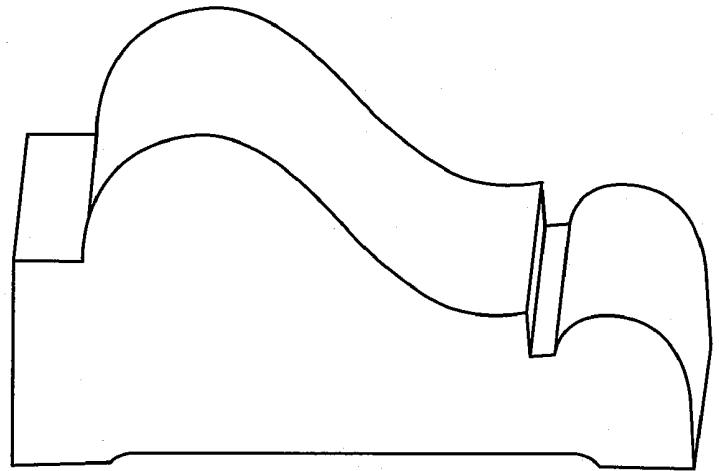

1510

1-5/8 X 3-1/2

1511  
1-11/16 X 4-7/8

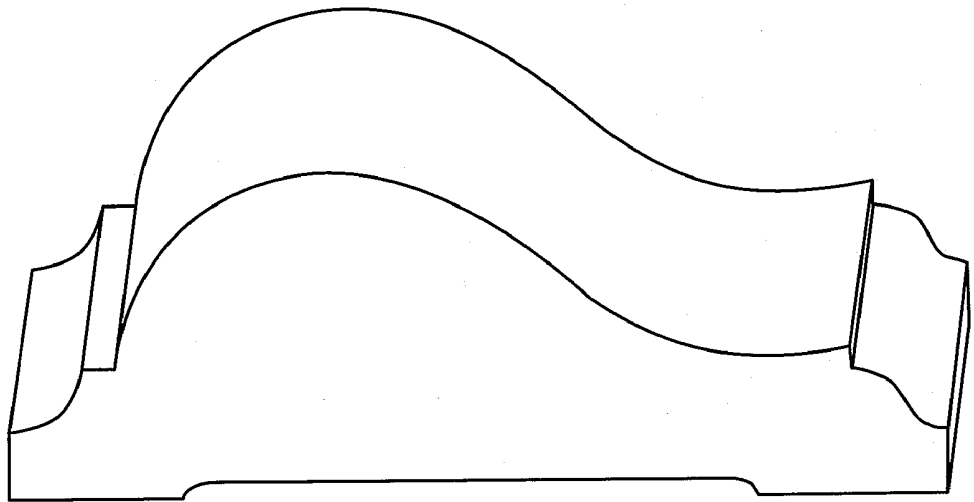

1512

1-7/16 X 5-5/16

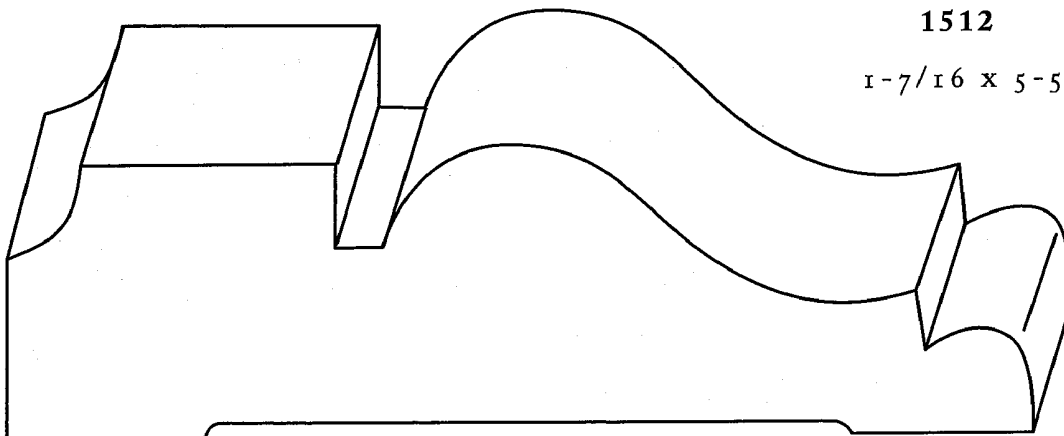

TONGUE & GROOVE

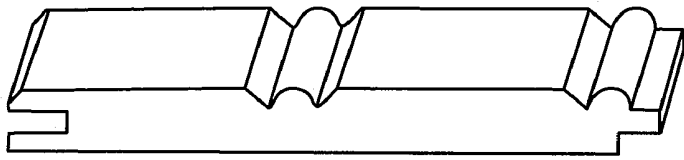

**1601**

1 1/32 x 3-3/8

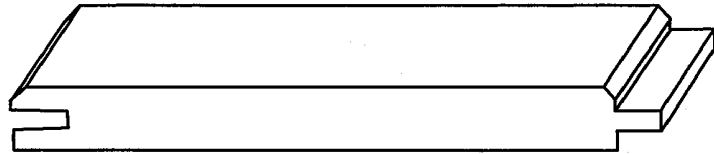

**1600**

1 1/32 x 3-3/8

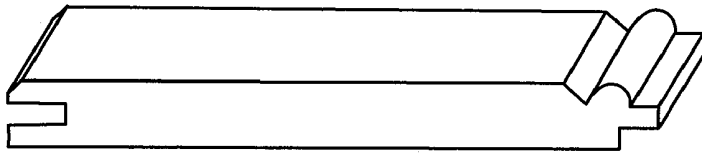

**1622**

1 1/32 x 3-3/8

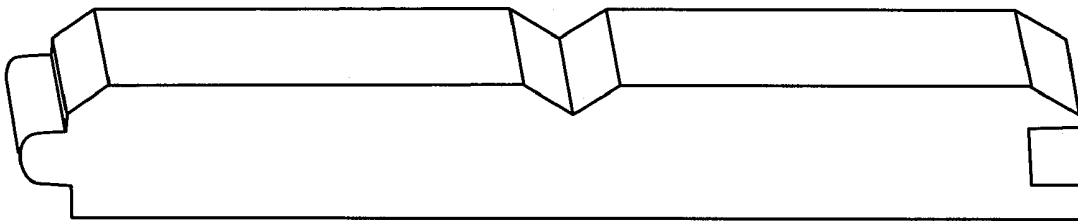

**1630**

3/4 x 5-1/2

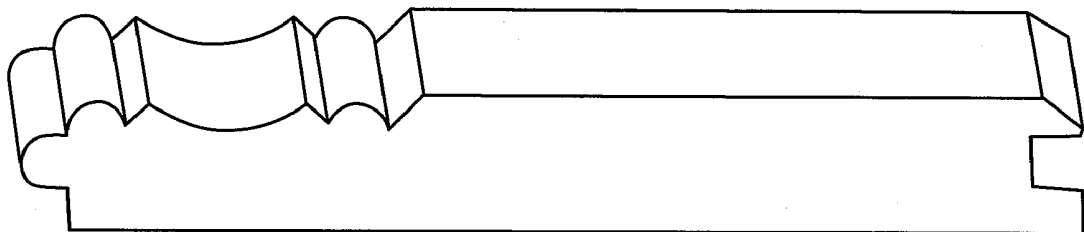

**1631**

3/4 x 5-1/2

PANEL & CAP MOULDS

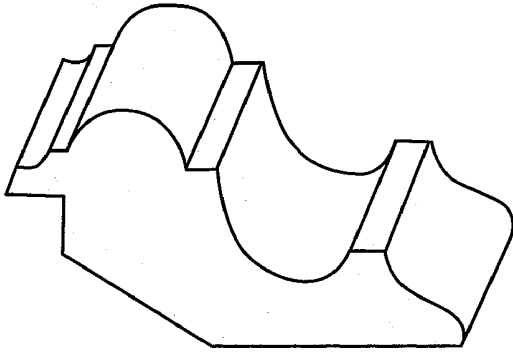

**1604**

3/4 X 2-7/16

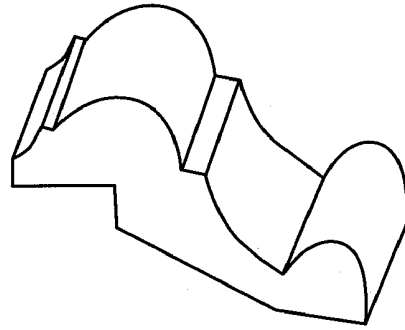

**1603**

3/4 X 2

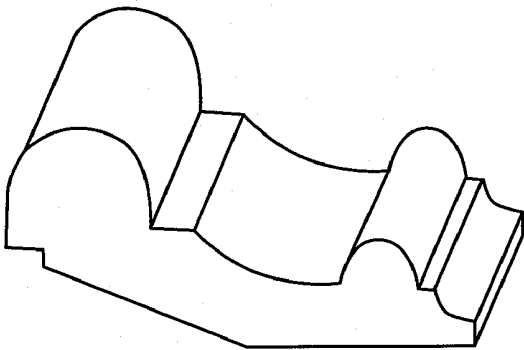

**1605**

3/4 X 2-1/2

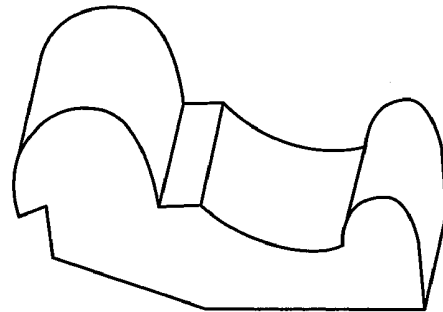

**1617**

3/4 X 2-1/8

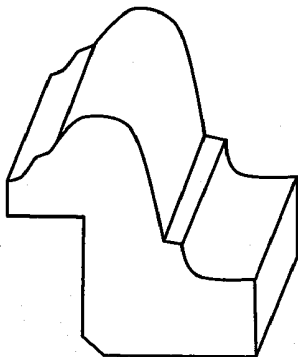

**1606**

1-1/4 X 1-1/4

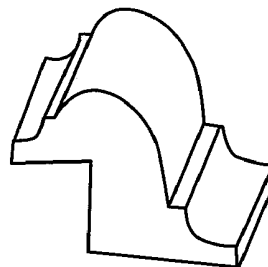

**1614**

7/8 X 1-1/8

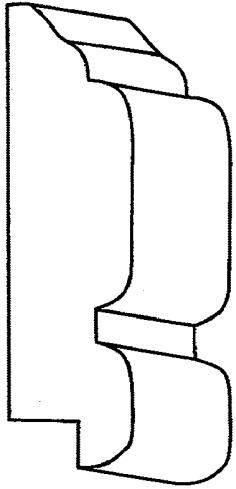

1607

5/8 x 2-7/16

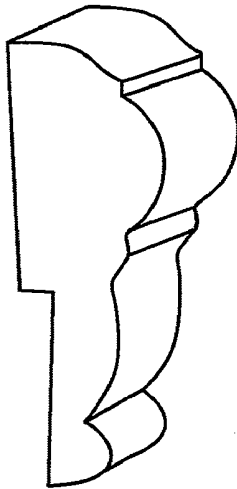

1619

3/4 x 2-5/16

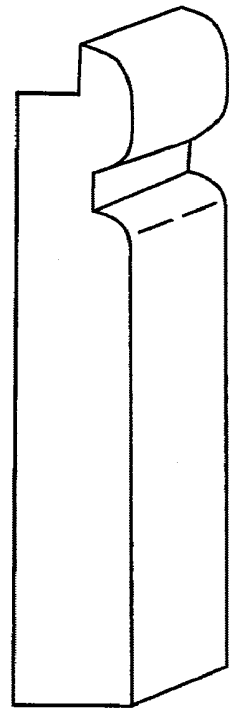

1629

5/8 x 3-7/16

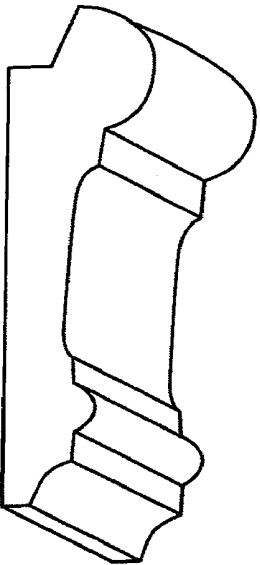

1621

11/16 x 2-5/8

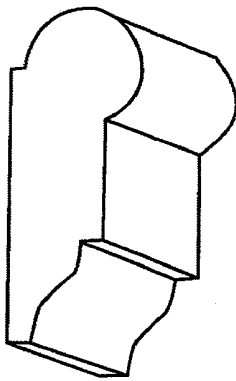

1620

11/16 x 1-3/4

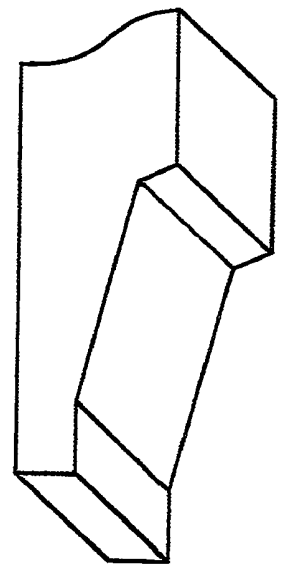

1623

13/16 x 2-7/16

PANEL & CAP MOULDS

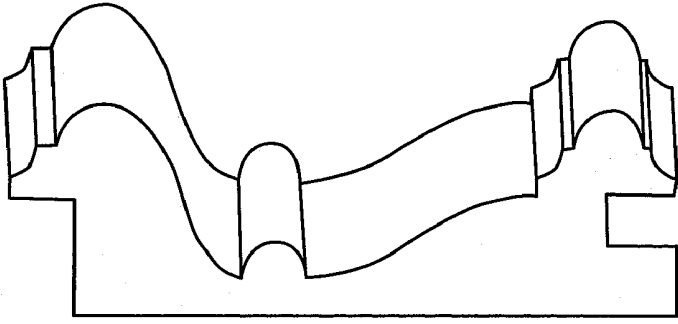

1616

1-1/16 X 3-7/16

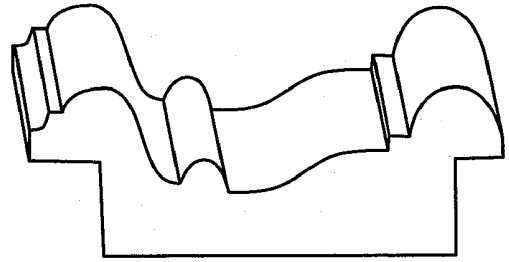

1615

13/16 X 2-7/16

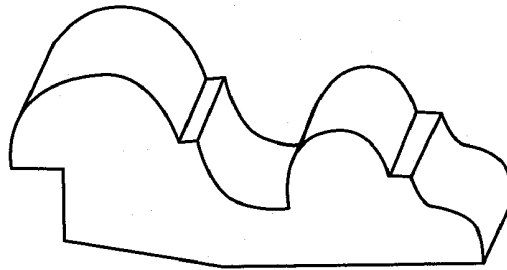

1628

1 X 2-7/16

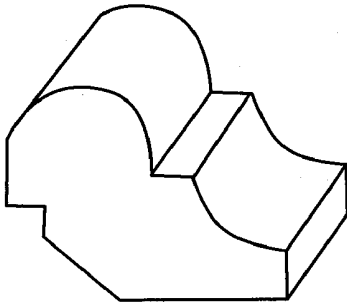

1618

3/4 X 1-5/8

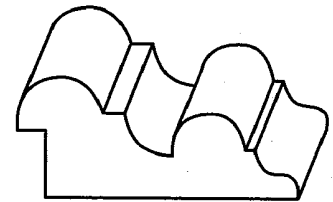

1627

5/8 X 1-1/2

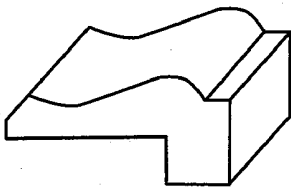

1602

9/16 X 1-1/8

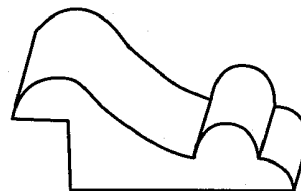

1626

5/8 X 1-1/2

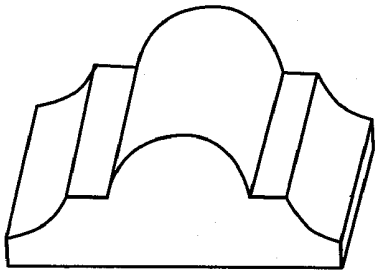

1705

11/16 X 1-3/4

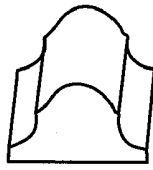

1707

7/16 X 3/4

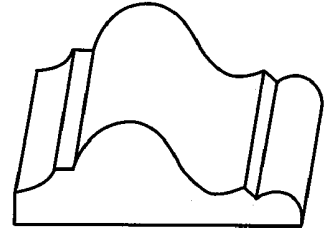

1703

9/16 X 1-1/2

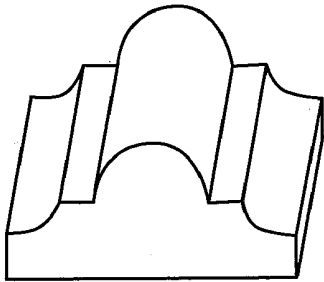

1704

11/16 X 1-1/2

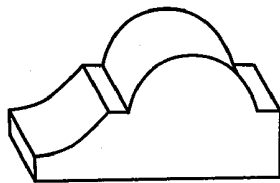

1716

11/16 X 1-3/8

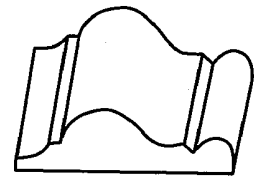

1702

5/16 X 1-1/8

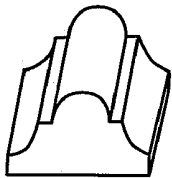

1706

7/16 X 3/4

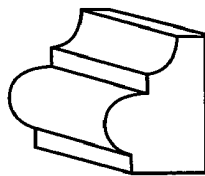

1700

9/16 X 3/4

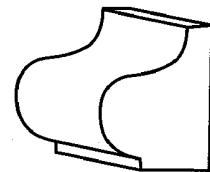

1708

1/2 X 3/4

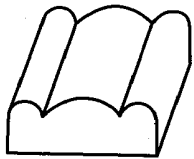

1924

1/4 X 3/4

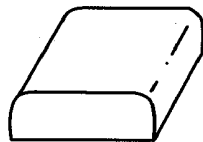

1910

1/4 X 3/4

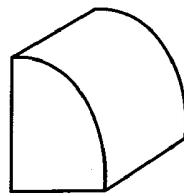

1900

1/2 X 3/4

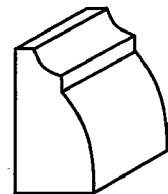

2900

3/8 X 3/4

MISCELLANEOUS & BACK BANDS

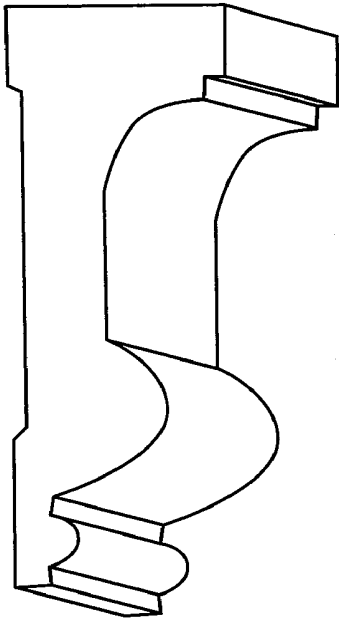

1711  
1-1/8 x 3

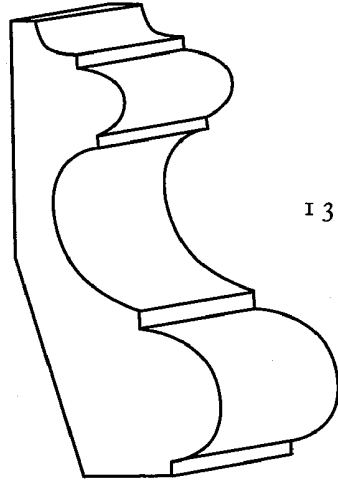

1712  
13/16 x 2-1/2

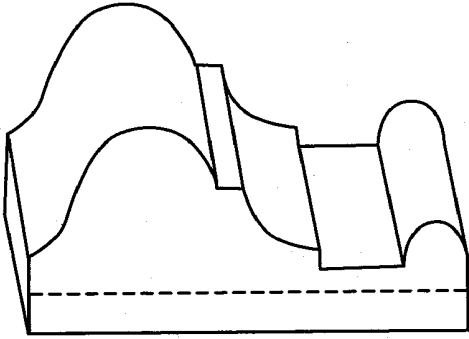

1713  
1-1/16 x 2-1/4

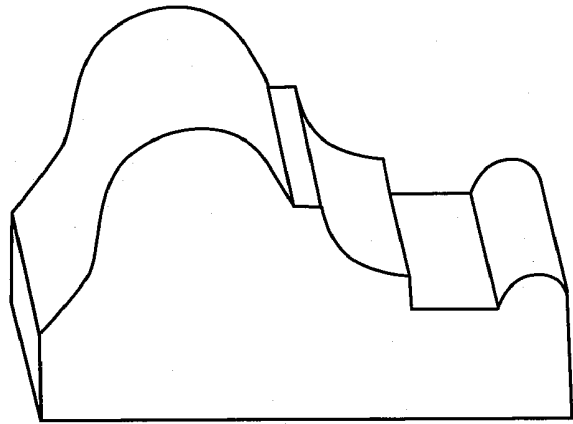

1715  
1-1/2 x 2-3/4

1714

7/8 x 2-1/4

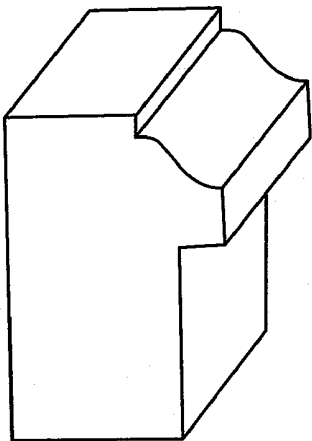

2002

1-1/8 x 1-11/16

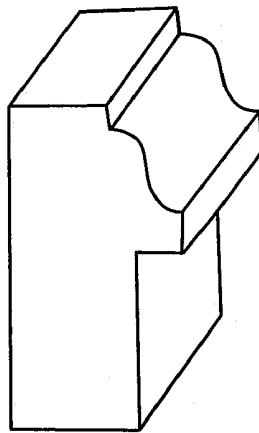

2003

7/8 x 1-11/16  
7/8" RAB

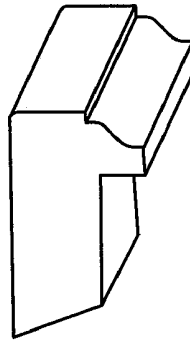

2001

11/16 x 1-3/16  
7/8" RAB

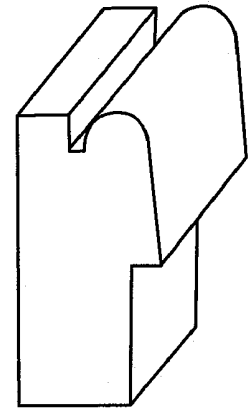

2000

3/4 x 1-1/2



WINDOW SILLS & NOSINGS

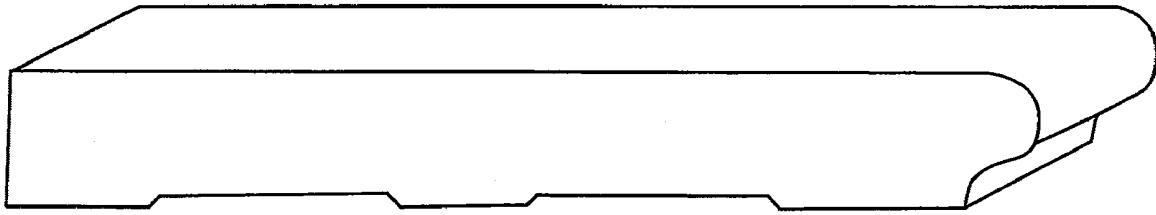

1800

11/16 x 5-7/16

1801

11/16 x 7-1/4

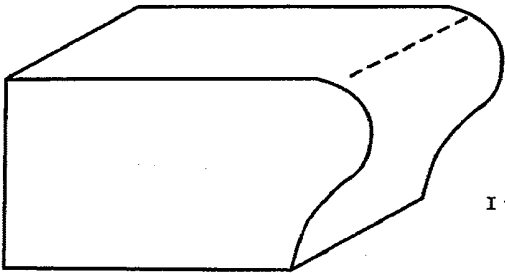

1610

1-1/16 x 2

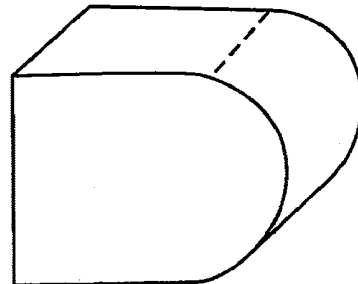

1816

1-1/8 x 1-7/16

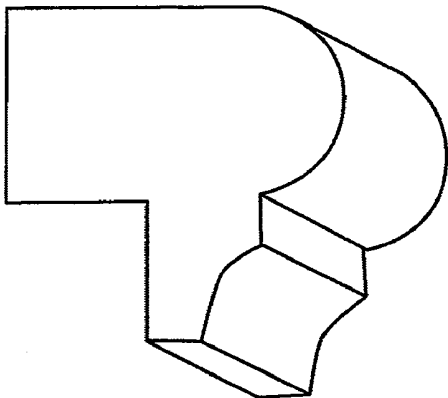

1609

1-3/4 x 1-3/4  
3/4" RAB

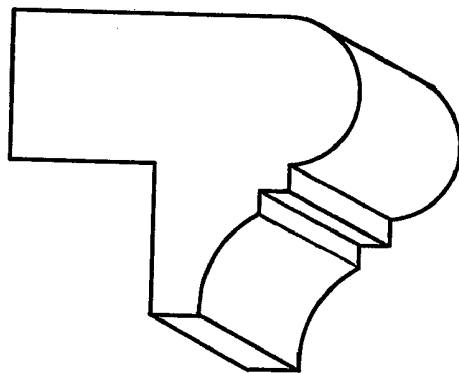

1611

1-13/16 x 1-9/16  
3/4" Rab

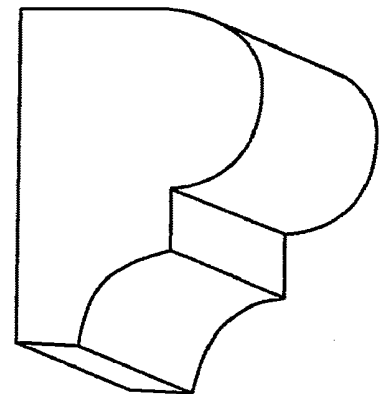

1608

1-1/4 x 1-3/4

BAR RAILS

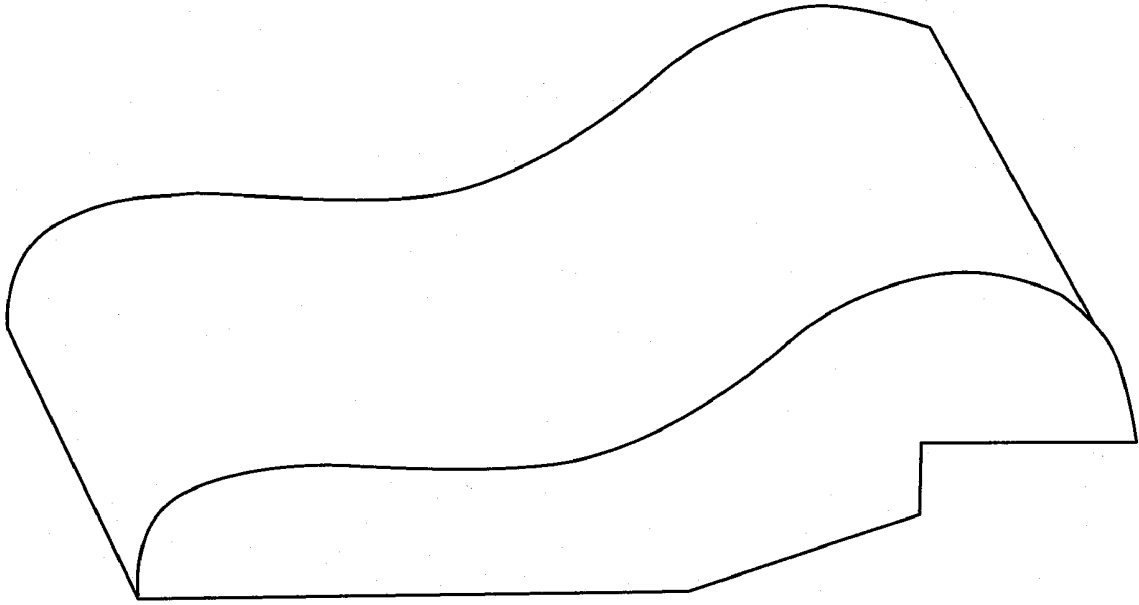

1811

1-3/8 x 5-1/4

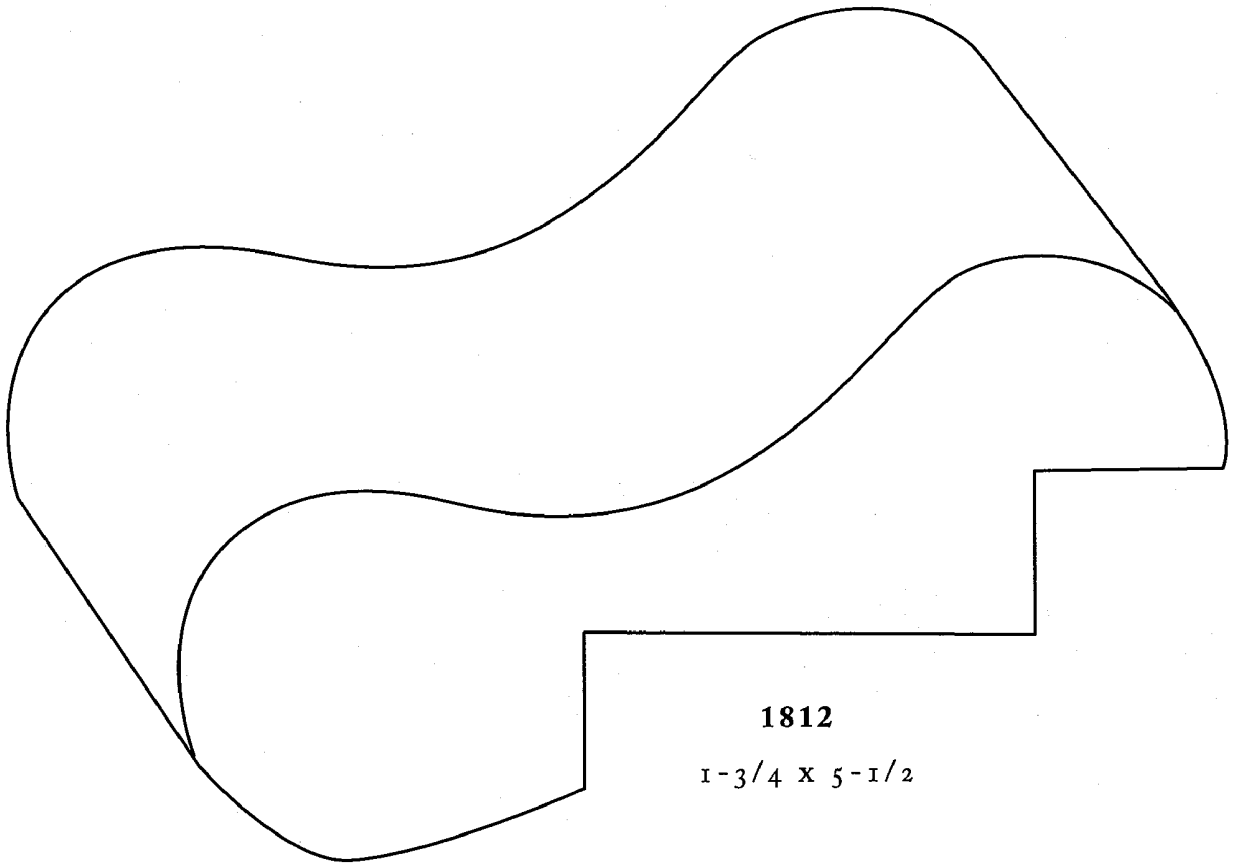

1812

1-3/4 x 5-1/2

PLATE RAILS

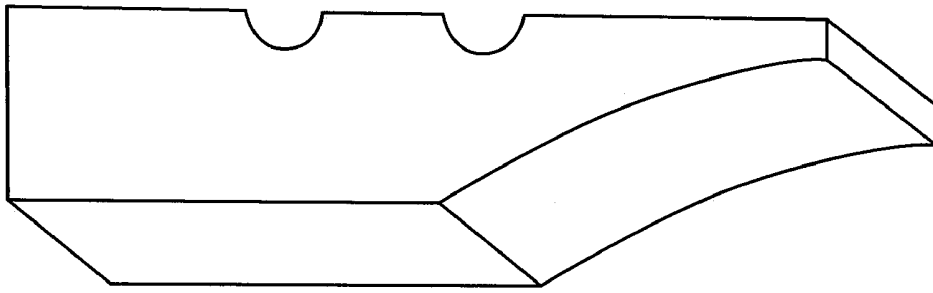

1820  
1 X 4-1/4

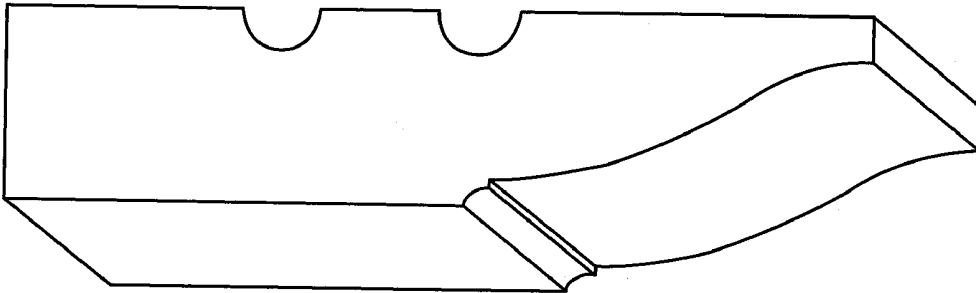

1821  
1 X 4-1/2

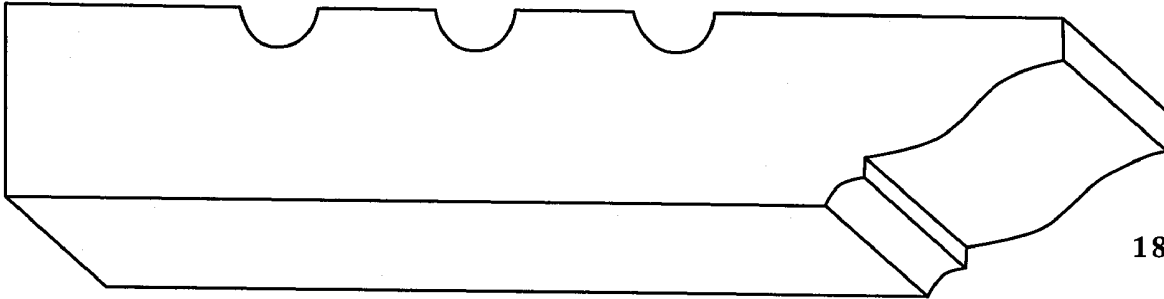

1822  
1 X 5-1/2

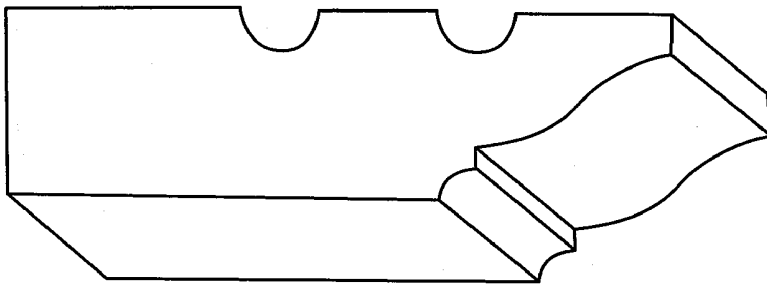

1823  
1 X 3-1/2

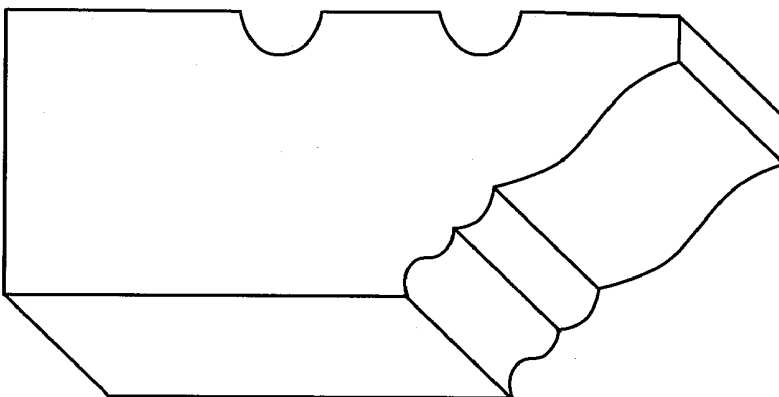

1824  
1-7/16 X 3-1/2

QUARTER, HALF, FULL ROUNDS & SCRIBES

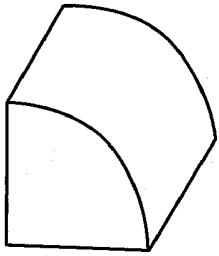

1904

3/4 x 3/4



1903

1/2 x 1/2



1902

3/8 x 3/8

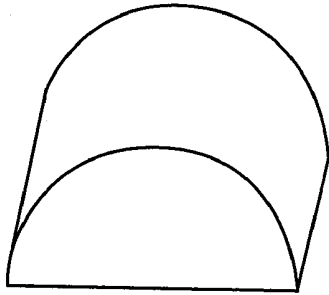

1907

3/4 x 1-1/2

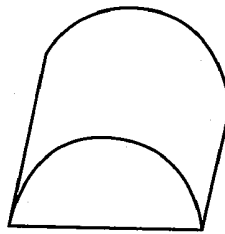

1906

1/2 x 1

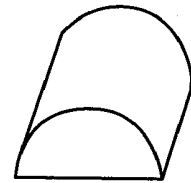

1905

3/8 x 3/4

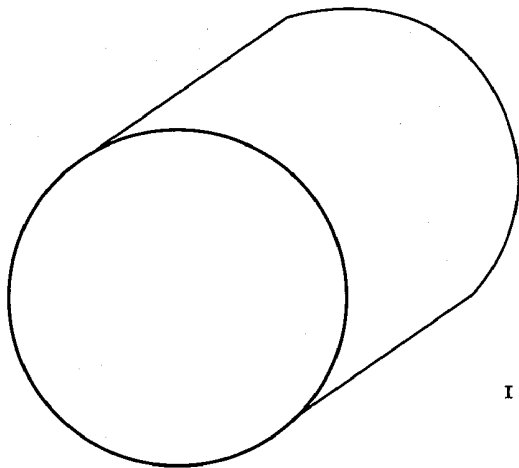

1909

1-3/4 DIA

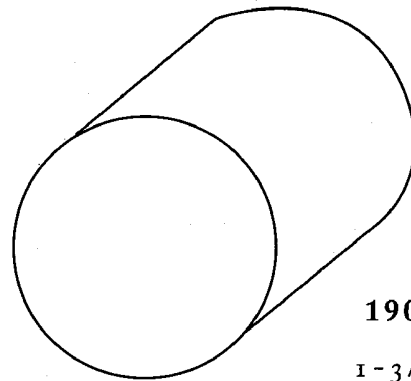

1908

1-3/8 DIA

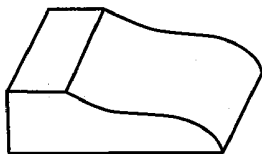

1914

5/16 x 1-1/8

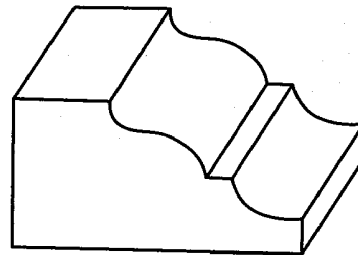

1913

13/16 x 1-1/2

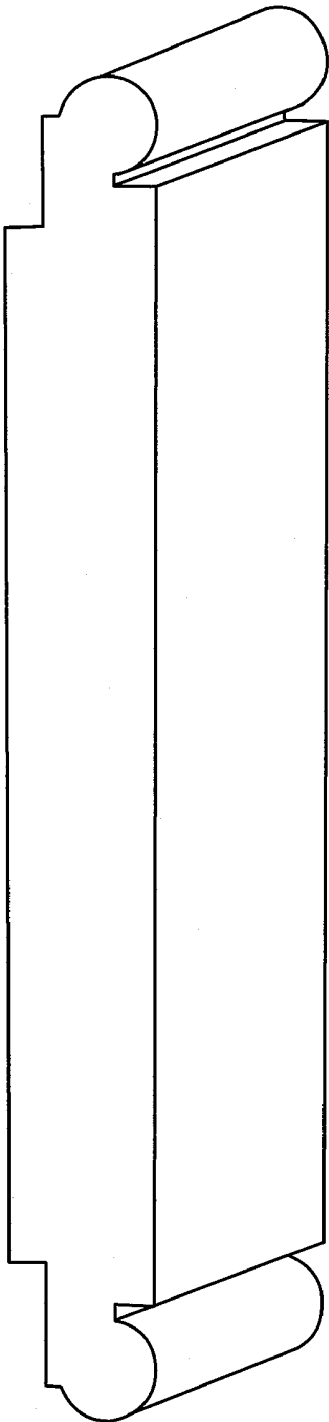

1919

3/4 x 7

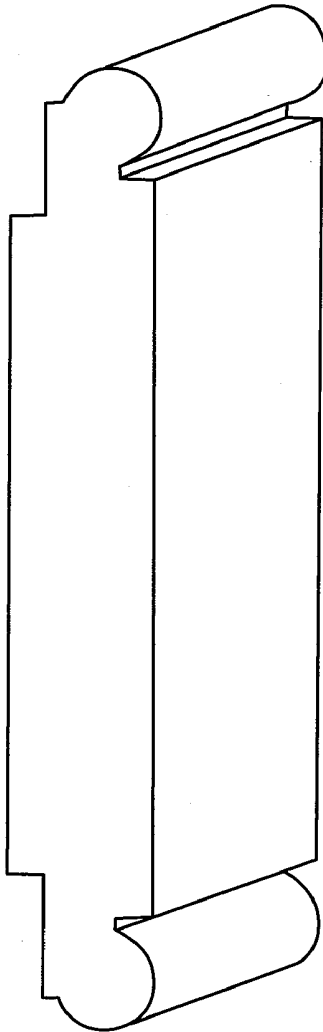

1918

3/4 x 5

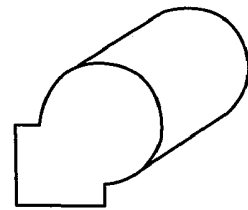

1920

3/4 x 3/4

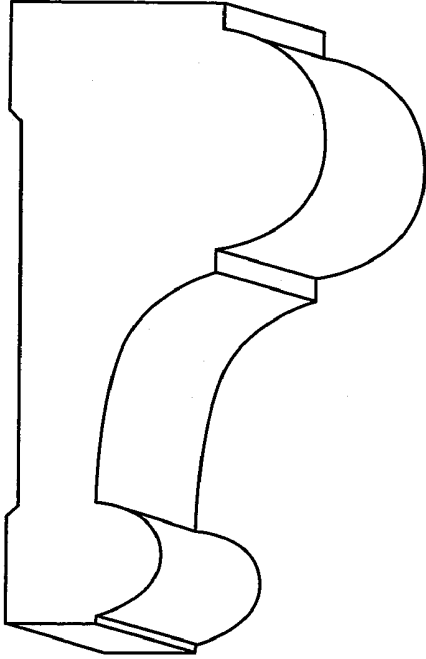

1915

1-5/8 x 3-1/4

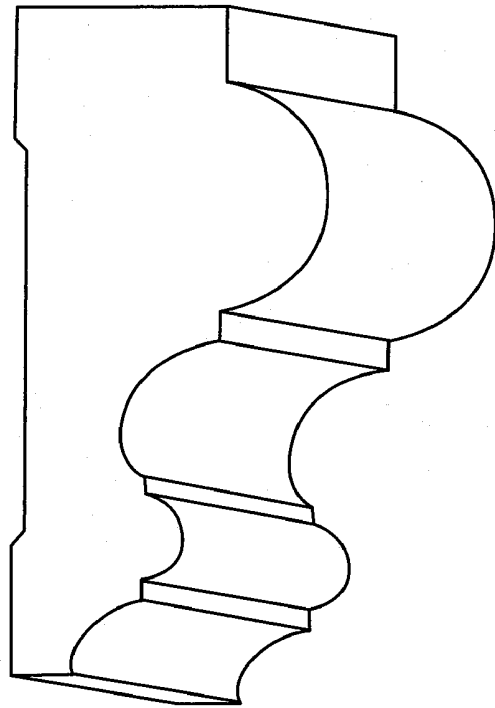

1925

1-5/8 x 3-1/2

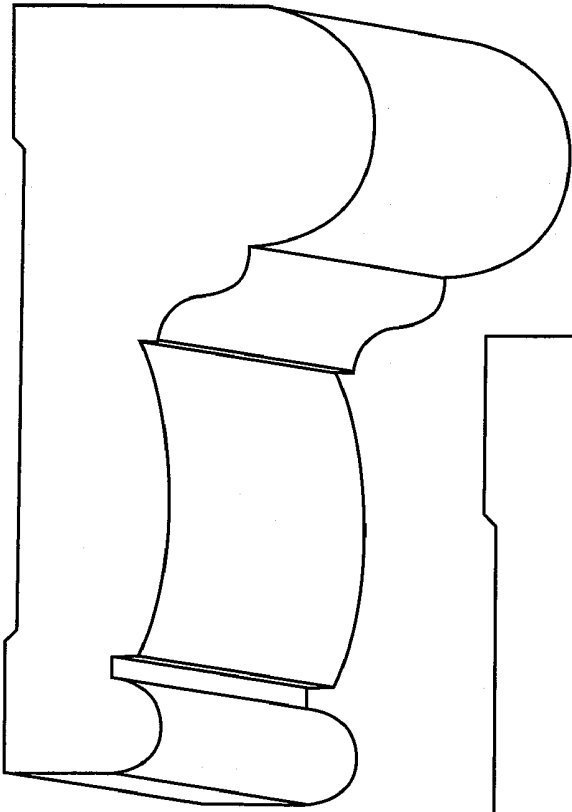

**1965**

1- 7/8 X 4

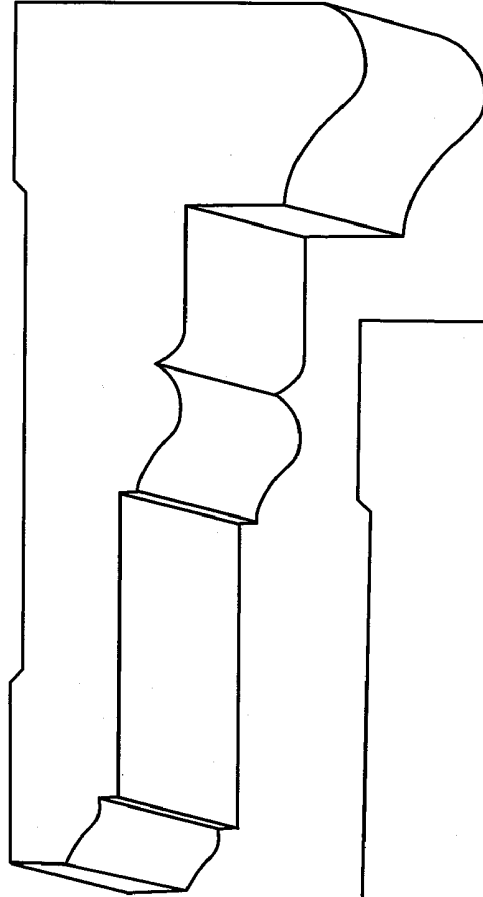

**1967**

1-13/16 X 4-1/2

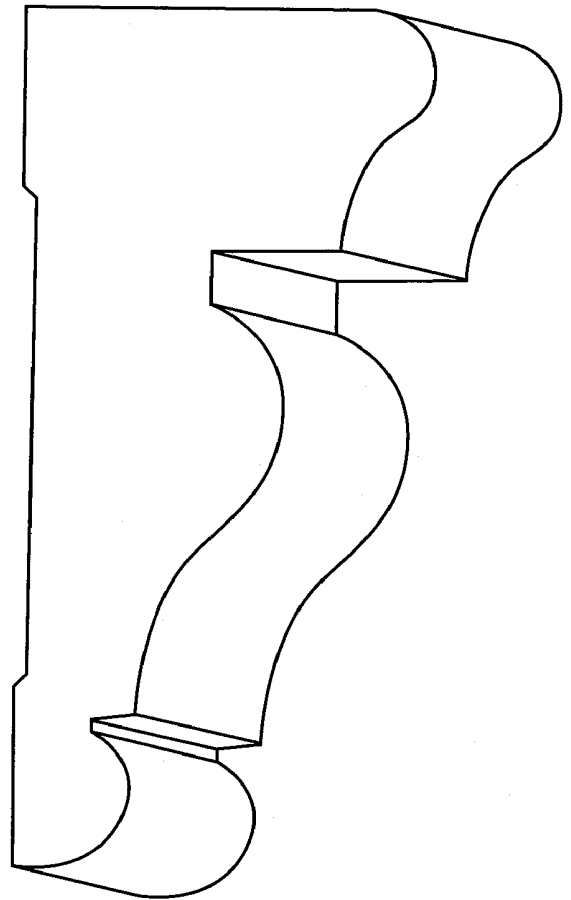

**1968**

2-1/8 X 4-1/2

LINTEL COMPONENTS

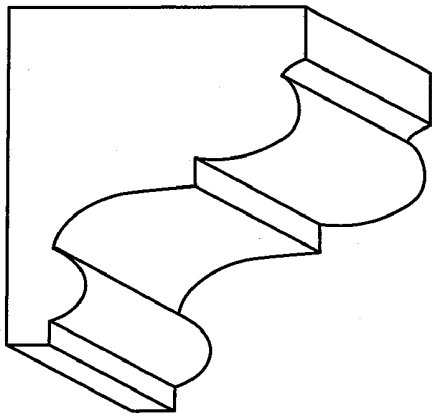

1927

1-7/16 X 1-3/4

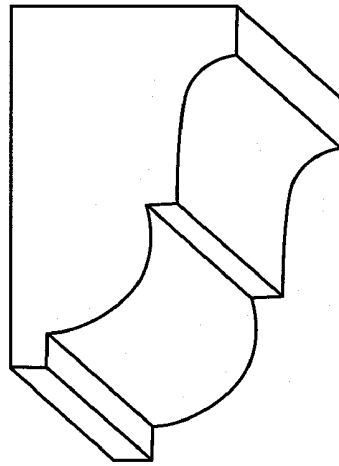

1930

1-1/8 X 1-7/8

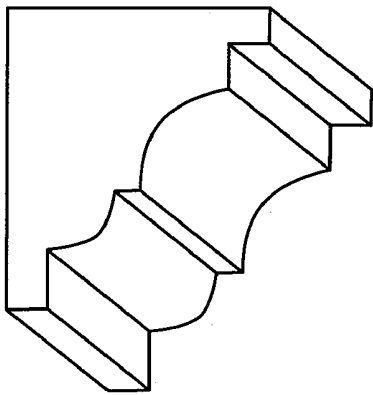

1916

1-5/16 X 1-9/16

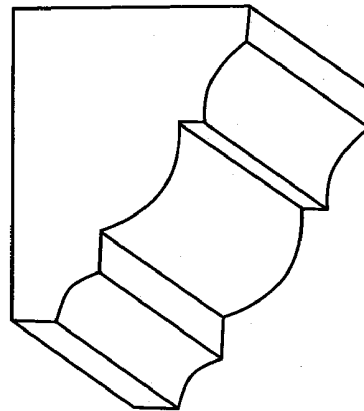

1931

1-1/8 X 1-5/8

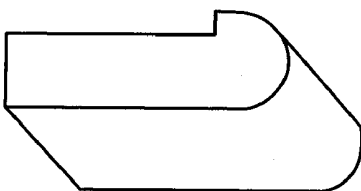

1923

1/2 X 1-7/16

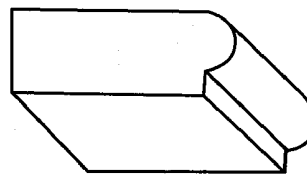

1917

7/16 X 1-1/8



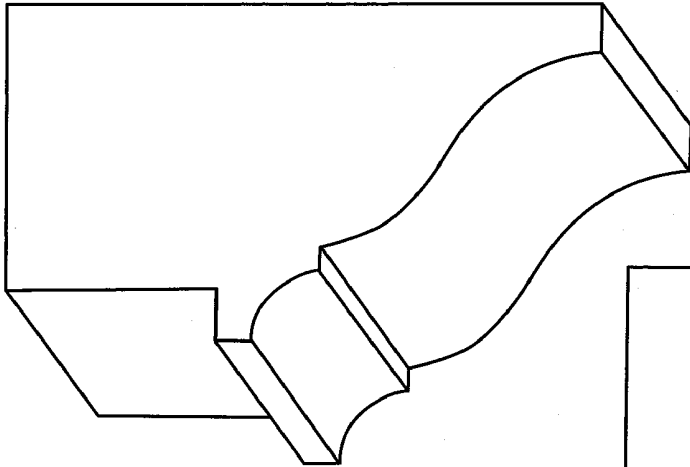

**1921**

1-3/4 X 3-1/16

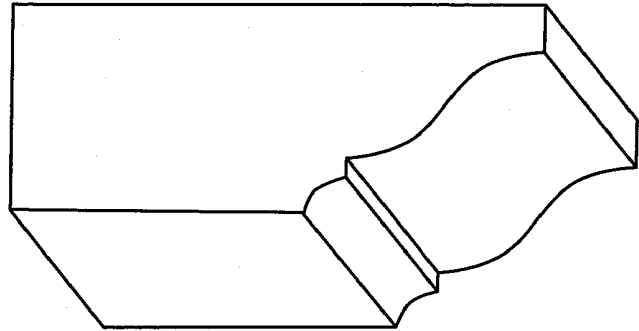

**1928**

1-1/8 X 2-3/4

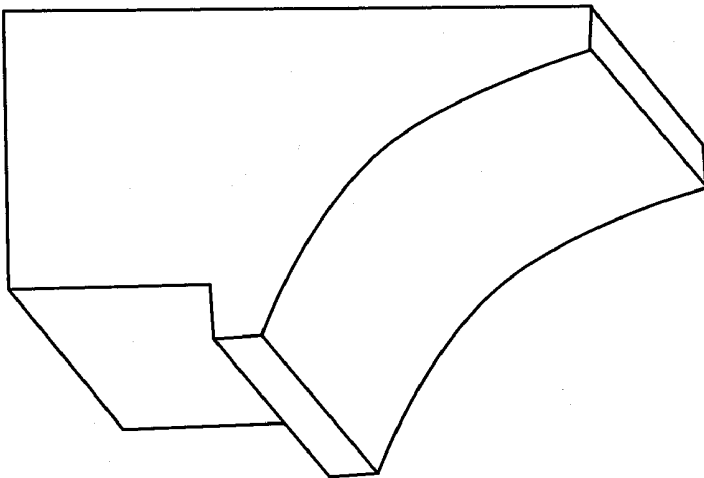

**1926**

1-3/4 X 3-1/16

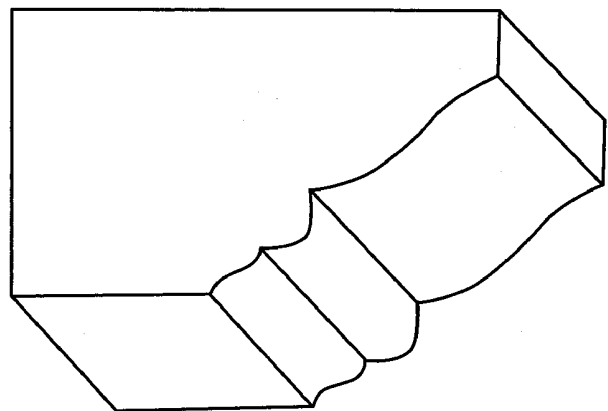

**1929**

1-1/2 X 2-1/2

BELLY BANDS

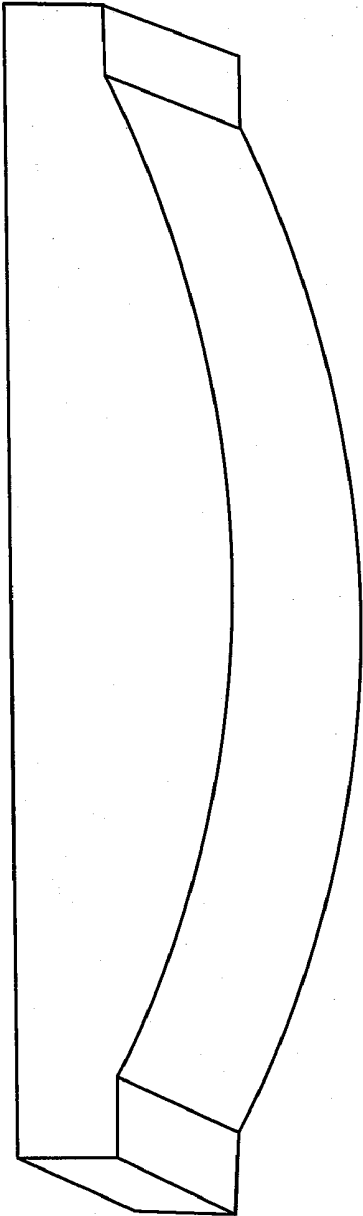

**3922**

1-1/16 x 6

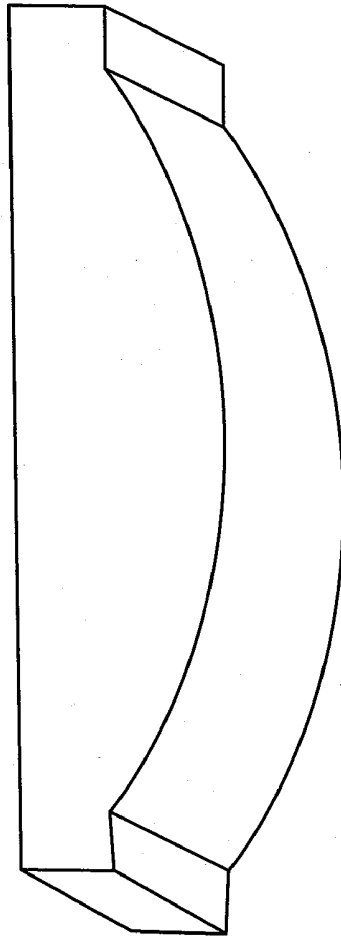

**2922**

1-1/16 x 4-1/2

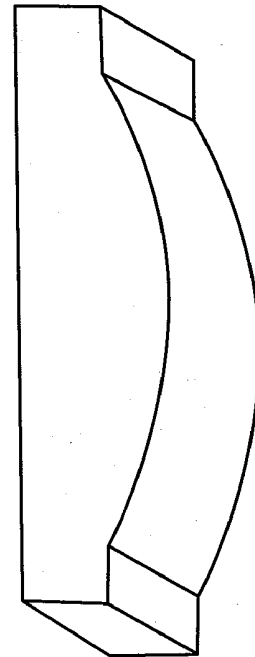

**1922**

11/16 x 3-1/8

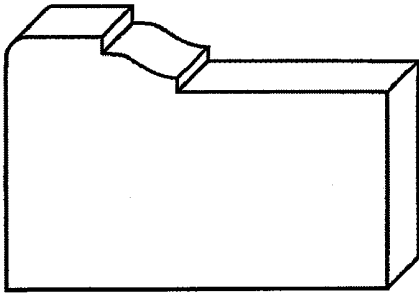

**E-2106**

1-5/16 x 2

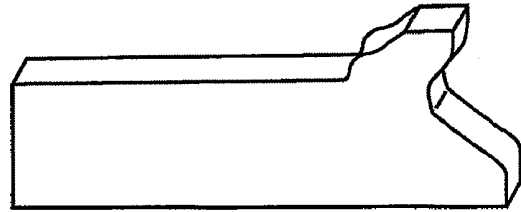

**E-2111**

15/16 x 2-5/8

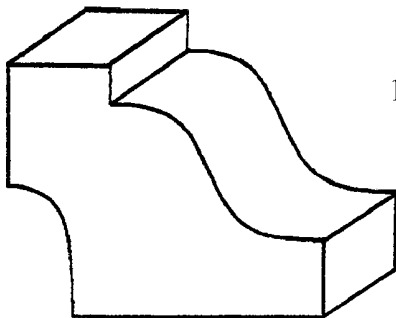

**E-2107**

1-5/16 x 1-5/8

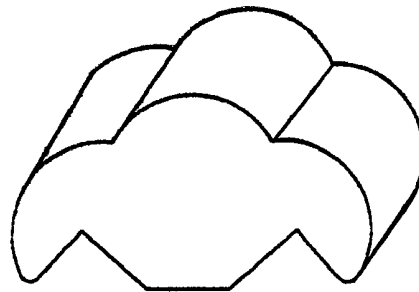

**E-2127**

1 x 1-7/8

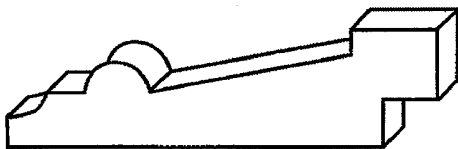

**E-2113**

5/8 x 2-1/4

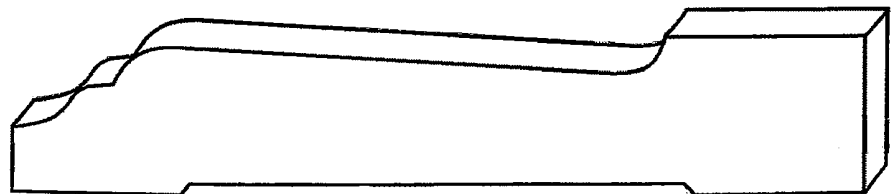

**E-2114**

13/16 x 4-1/2

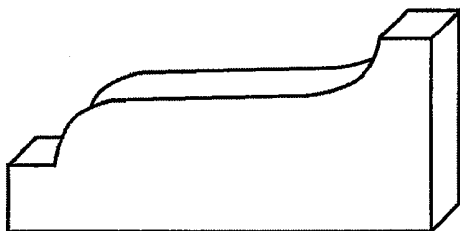

**E-2115**

1 x 2-1/4

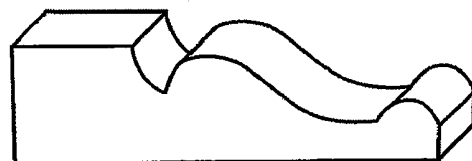

**E-2116**

5/8 x 2-1/4

EXTERIOR GRADE MOULDING

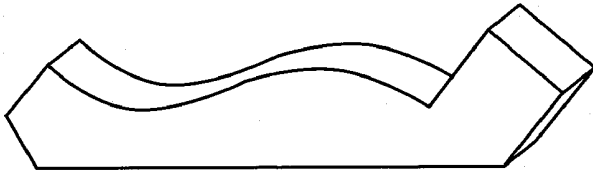

E-2117

11/16 x 2-15/16

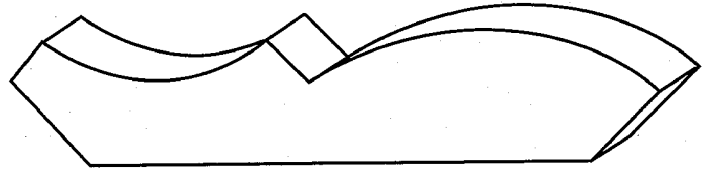

E-2118

11/16 x 3-3/8

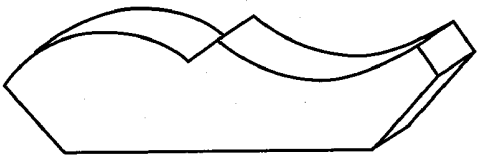

E-2119

5/8 x 2-1/4

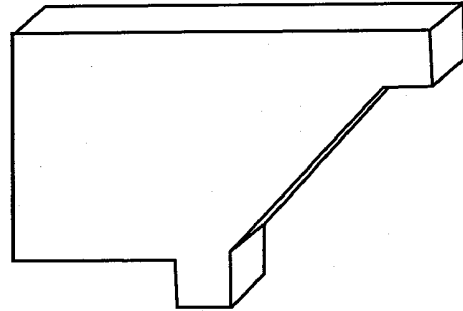

E-2120

1-7/16 x 2-3/16

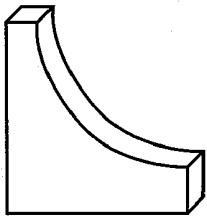

E-2121

1 X 1

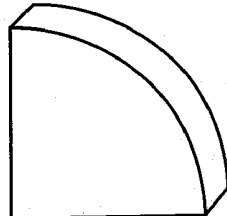

E-2122

1 X 1

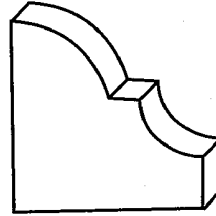

E-2123

1 X 1

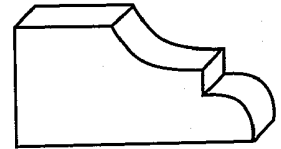

E-2124

5/8 x 1-1/4

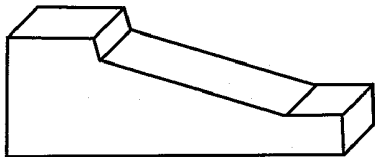

E-2125

5/8 x 1-3/4

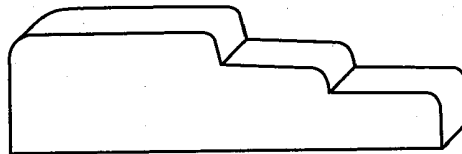

E-2126

5/8 x 2-1/4

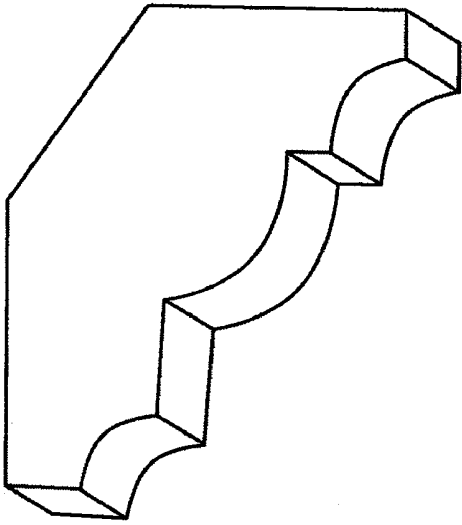

**E-2100**  
1-1/4 x 3-1/4

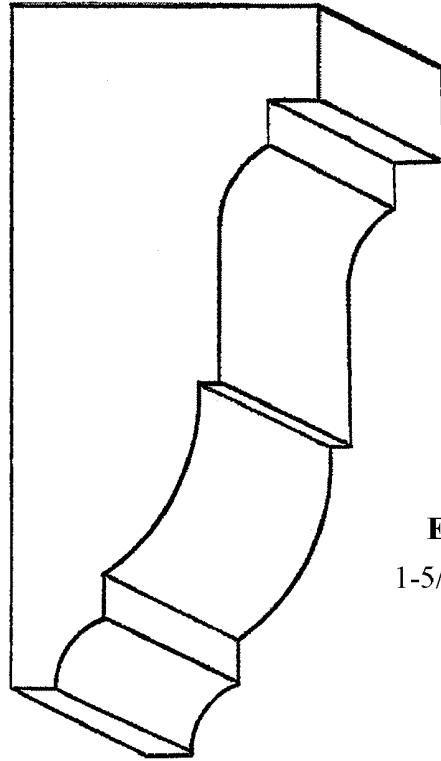

**E-5280**  
1-5/8 x 3-5/8

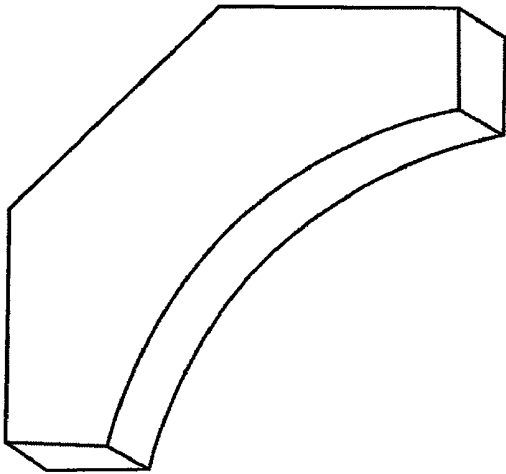

**E-2104**  
1-1/4 x 3-1/4

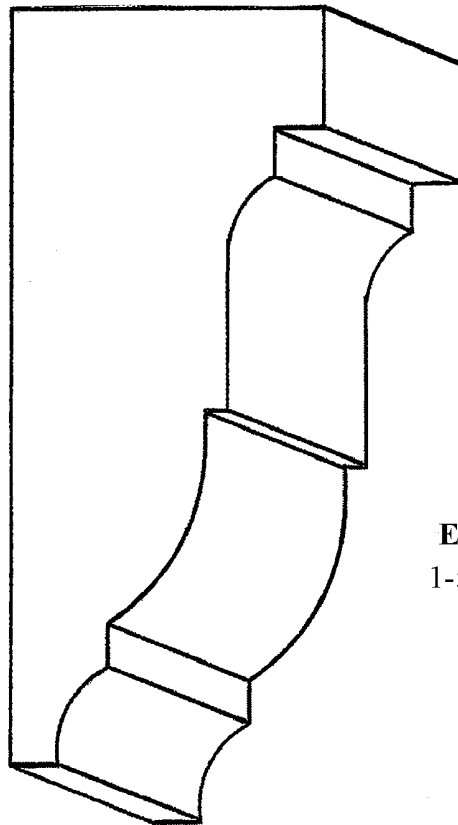

**E-5281**  
1-5/8 x 4

# WHITE BROTHERS - HANDRAILS

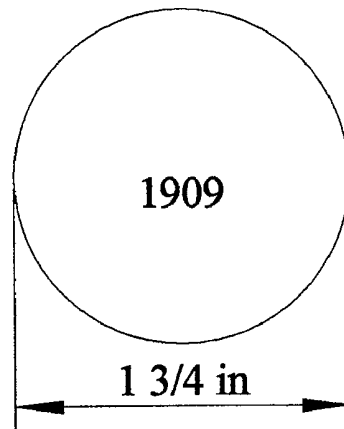
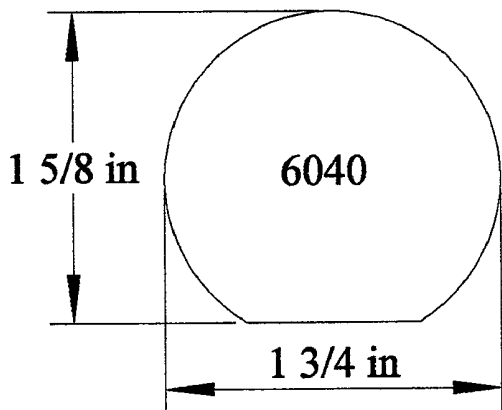
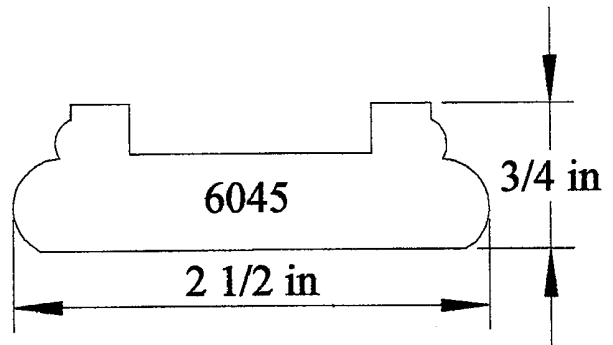
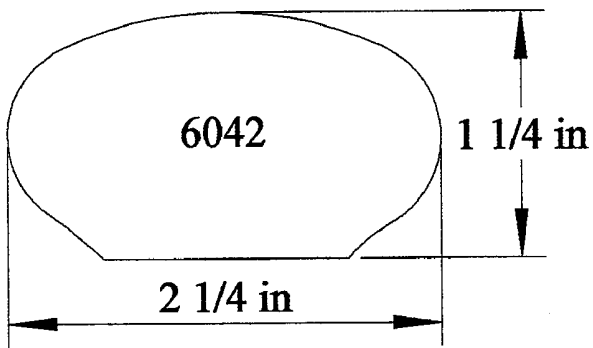
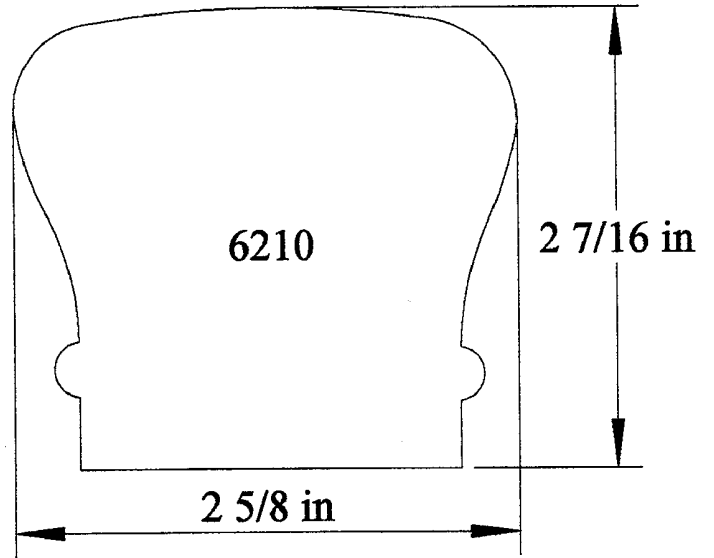
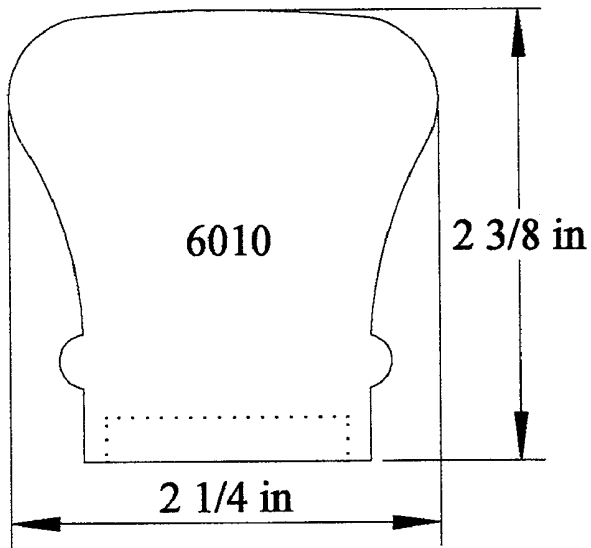

# WHITE BROTHERS - HANDRAILS

