

EXTERIOR GRADE MOULDINGS

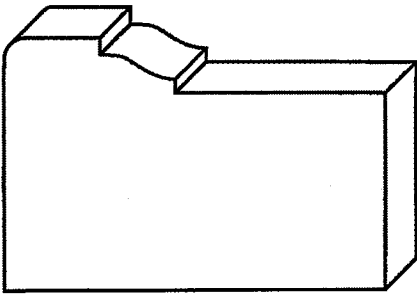

E-2106

$1-5/16 \times 2$

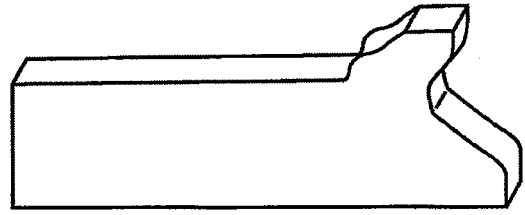

E-2111

$15/16 \times 2-5/8$

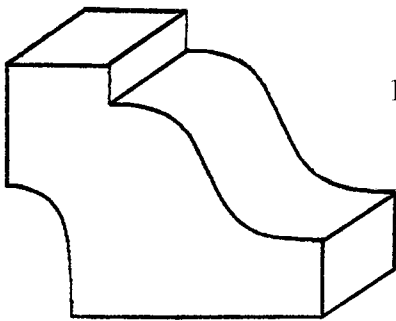

E-2107

$1-5/16 \times 1-5/8$

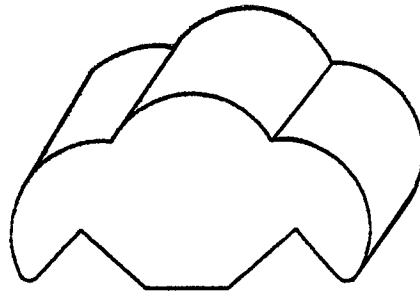

E-2127

$1 \times 1-7/8$

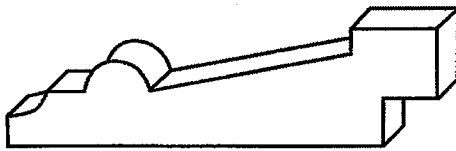

E-2113

$5/8 \times 2-1/4$

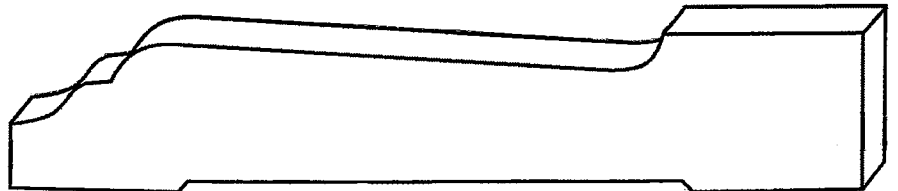

E-2114

$13/16 \times 4-1/2$

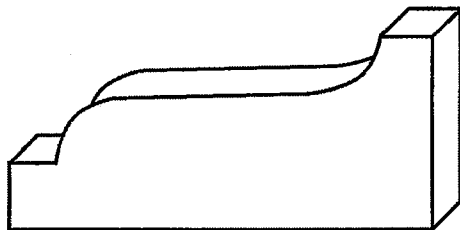

E-2115

$1 \times 2-1/4$



E-2116

$5/8 \times 2-1/4$

EXTERIOR GRADE MOULDING

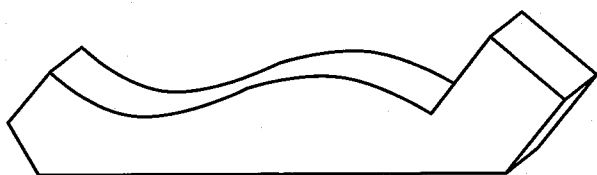

E-2117

$1\frac{1}{16} \times 2\frac{15}{16}$

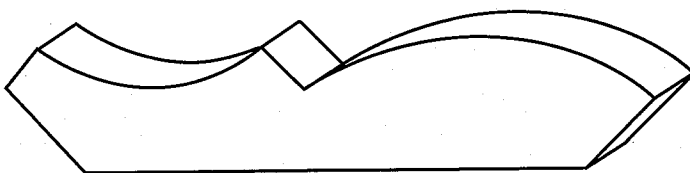

E-2118

$1\frac{1}{16} \times 3\frac{3}{8}$

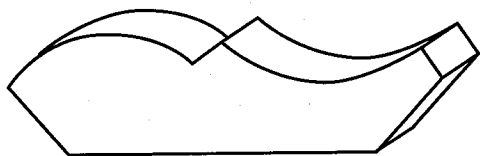

E-2119

$\frac{5}{8} \times 2\frac{1}{4}$

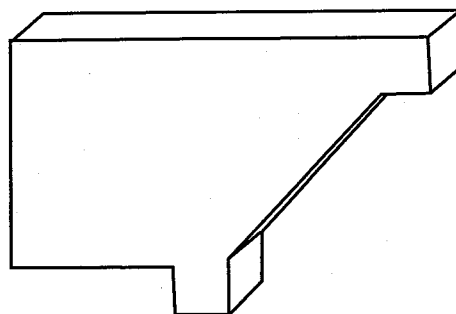

E-2120

$1\frac{7}{16} \times 2\frac{3}{16}$

68

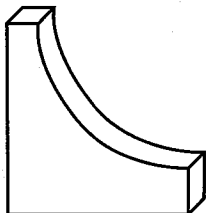

E-2121

1 X 1

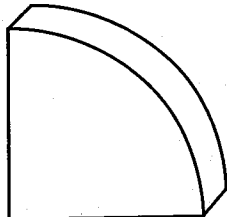

E-2122

1 X 1

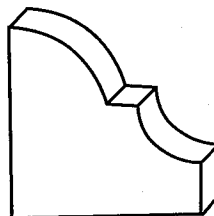

E-2123

1 X 1

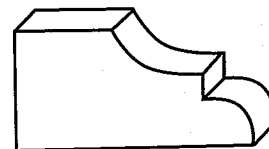

E-2124

$\frac{5}{8} \times 1\frac{1}{4}$

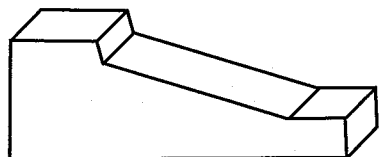

E-2125

$\frac{5}{8} \times 1\frac{3}{4}$

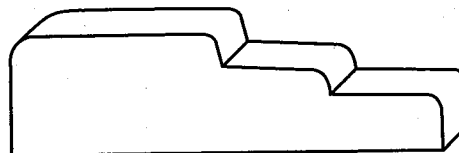

E-2126

$\frac{5}{8} \times 2\frac{1}{4}$

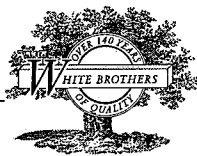

GUTTER MOULDS & CROWNS

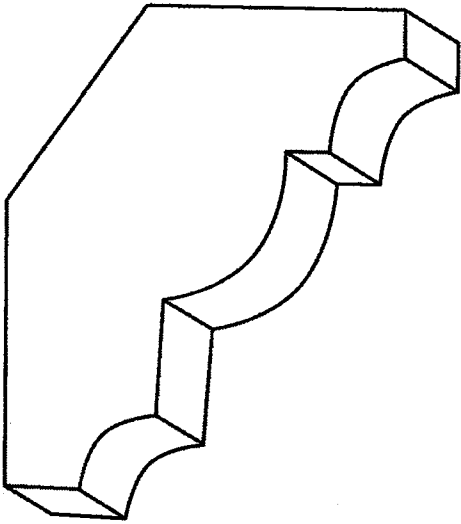

E-2100
1-1/4 x 3-1/4

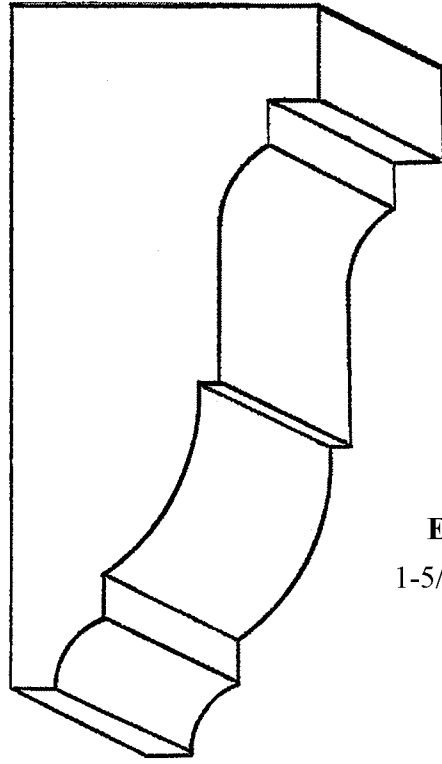

E-5280
1-5/8 x 3-5/8

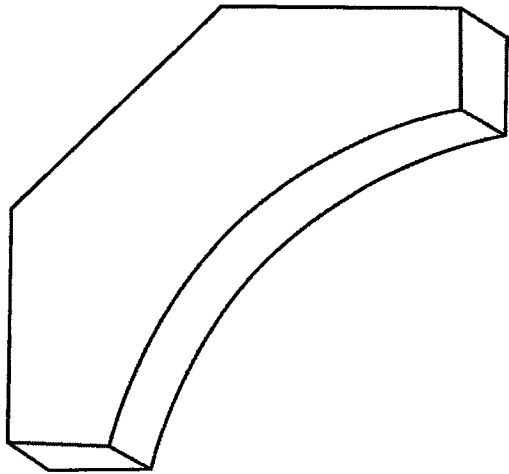

E-2104
1-1/4 x 3-1/4

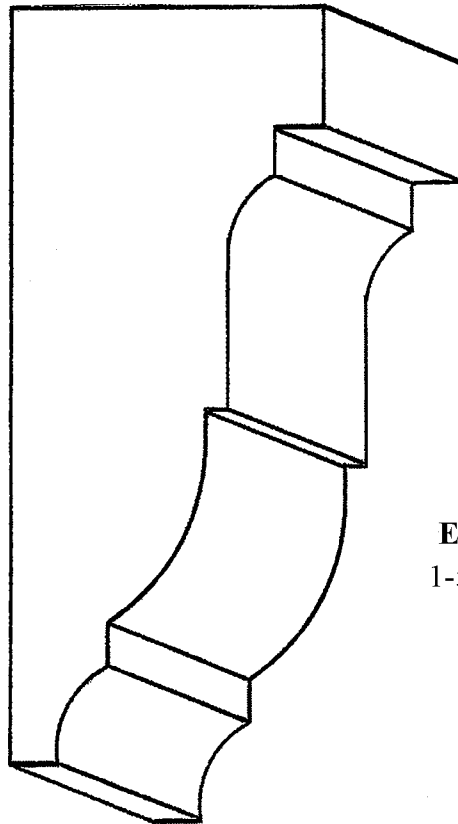

E-5281
1-5/8 x 4