

1915

1-5/8 X 3-1/4

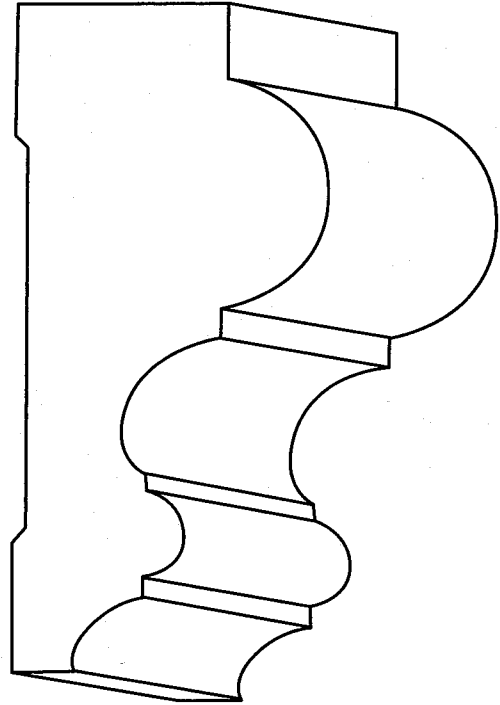

1925

1-5/8 X 3-1/2

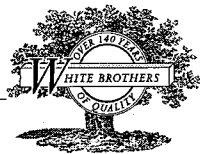

STOOL & APRON COMBO'S

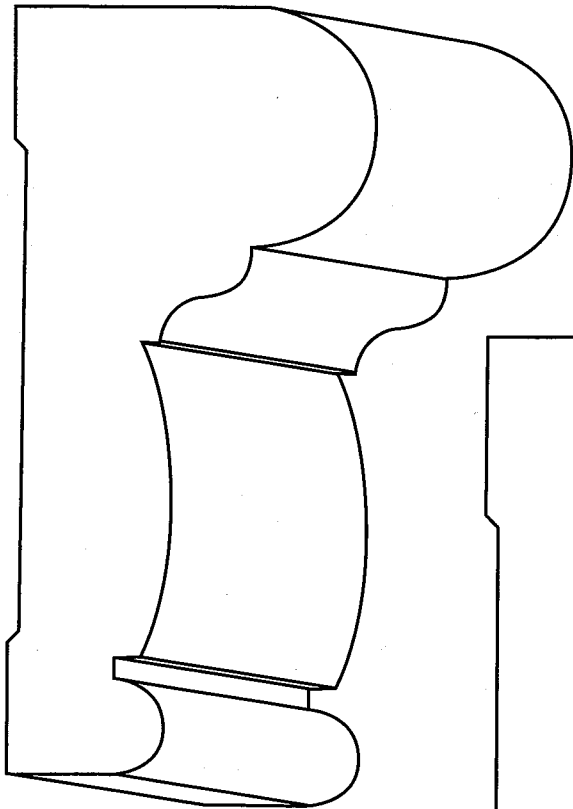

1965

1 - 7/8 x 4

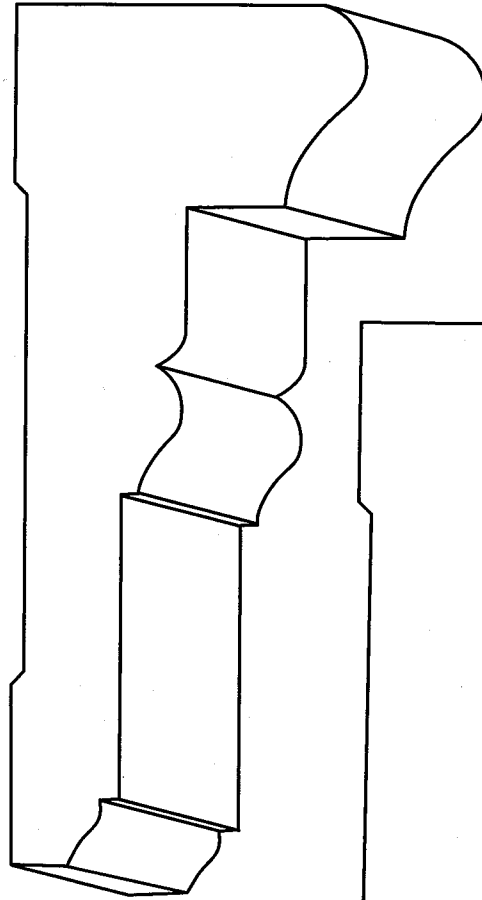

1967

1 - 13/16 x 4 - 1/2

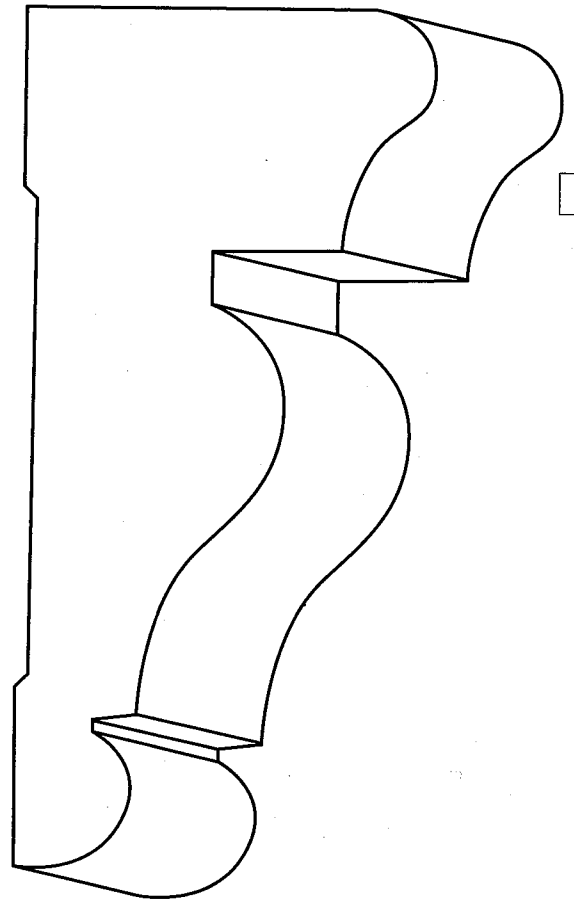

1968

2 - 1/8 x 4 - 1/2

WINDOW SILLS & NOSINGS

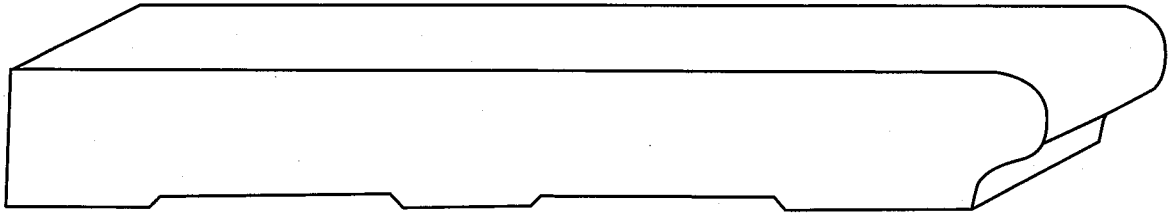

1800

1801

$1\frac{1}{16} \times 5\frac{7}{16}$

$1\frac{1}{16} \times 7\frac{1}{4}$

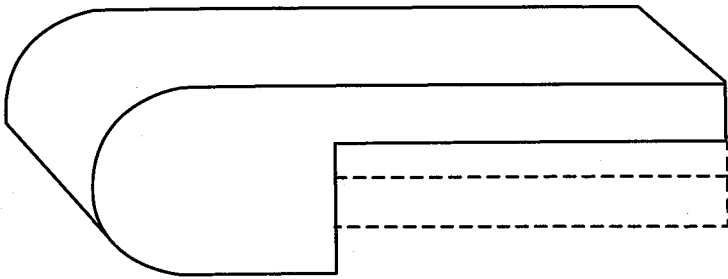

1813

1815

$1\frac{1}{16} \times 3\frac{1}{4} (5/16)$

$1\frac{1}{16} \times 3\frac{1}{4} (3/4)$

1814

1818

$1\frac{1}{16} \times 3\frac{1}{4} (1/2)$

$1\frac{1}{16} \times 5\frac{1}{4} (3/4)$

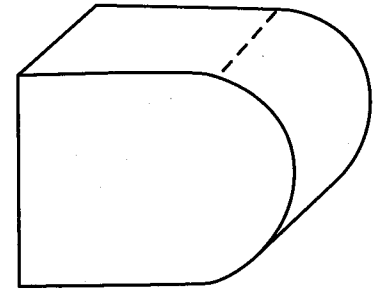

1816

$1\frac{1}{8} \times 1\frac{7}{16}$

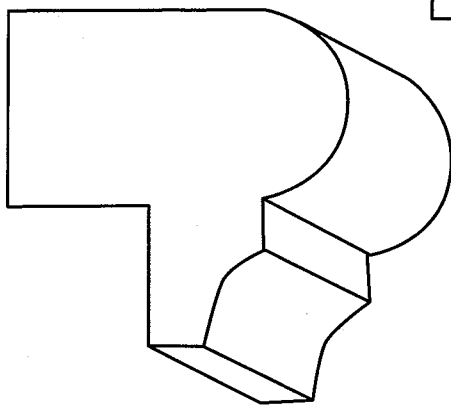

1609

$1\frac{3}{4} \times 1\frac{3}{4}$

$3/4''$ RAB

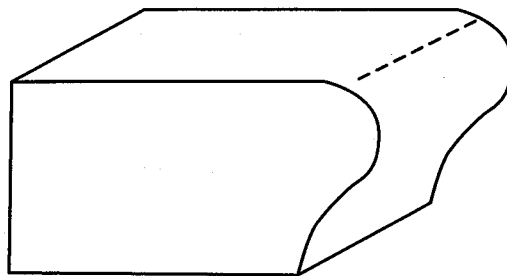

1610

$1\frac{1}{16} \times 2$

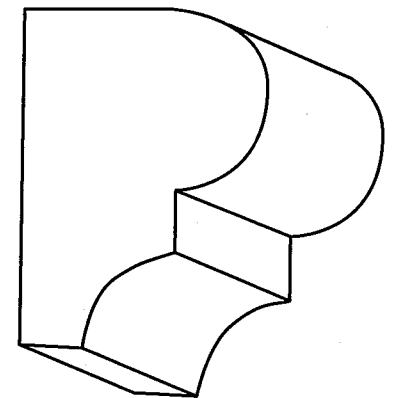

1608

$1\frac{1}{4} \times 1\frac{3}{4}$

APRONS

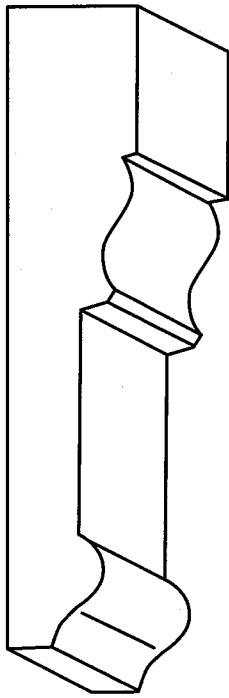

1244

$11/16 \times 3-5/16$

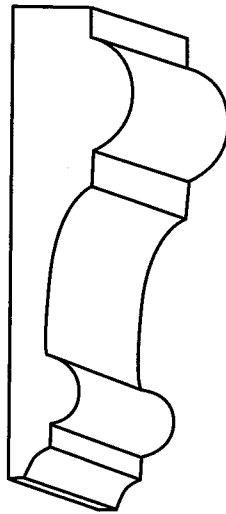

1247

$11/16 \times 2-7/16$

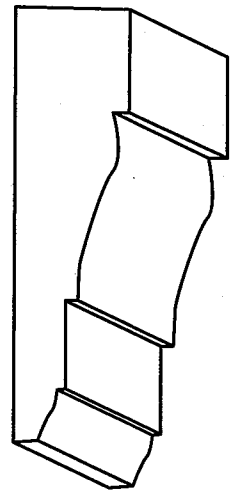

1245

$5/8 \times 2-1/4$

34

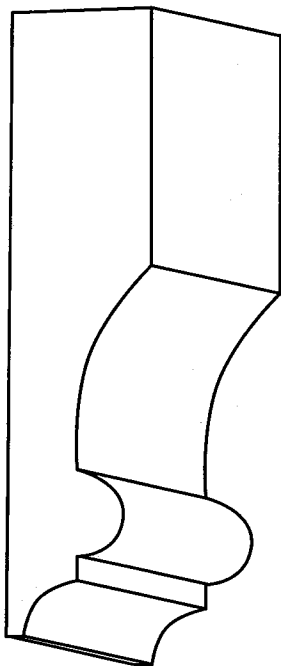

1241

$13/16 \times 3-1/4$

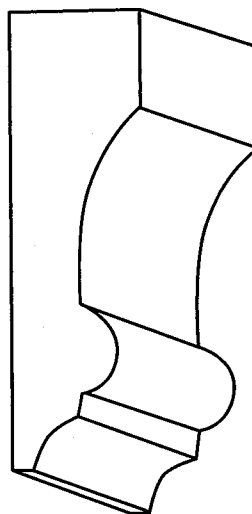

1240

$11/16 \times 2-3/8$

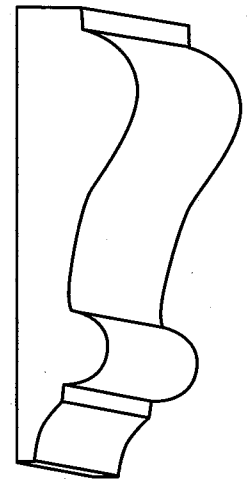

1246

$11/16 \times 2-3/8$



APRONS

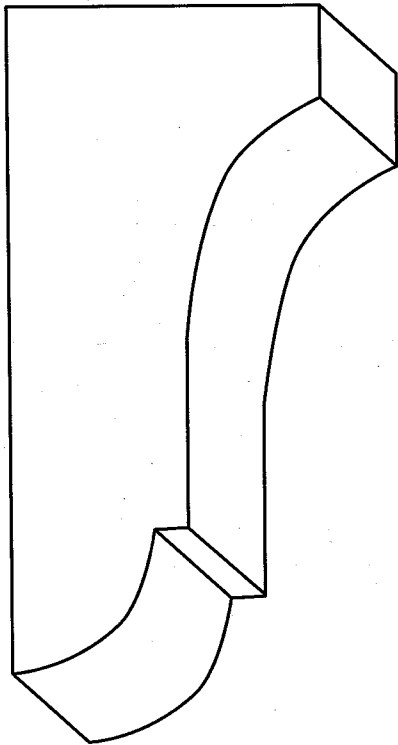

1243

1-5/8 x 3-7/16

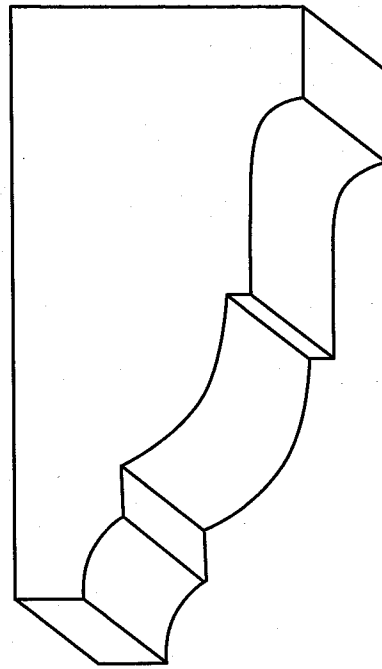

1242

1-1/2 x 3-1/16

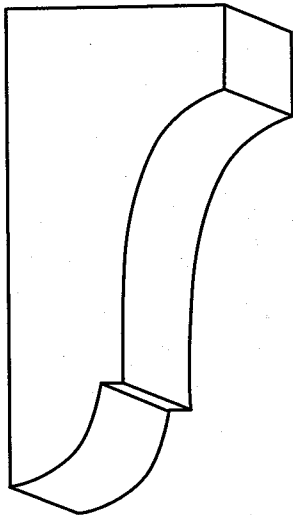

1263

1-1/8 x 2-1/2

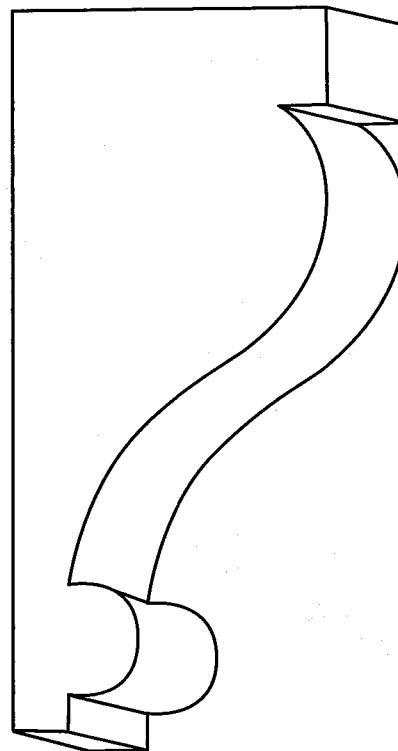

1264

1-5/8 x 3-3/4