

LINTEL COMPONENTS

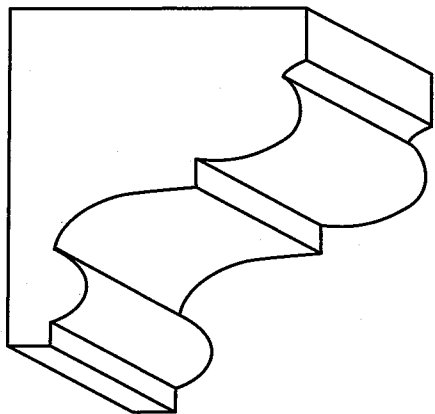

1927

1-7/16 X 1-3/4

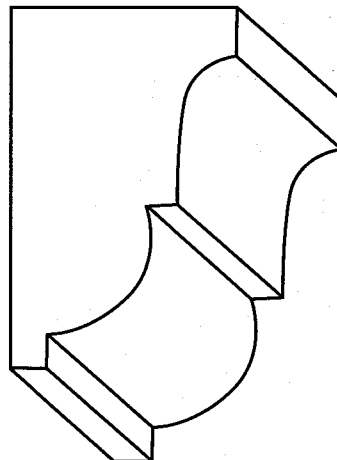

1930

1-1/8 X 1-7/8

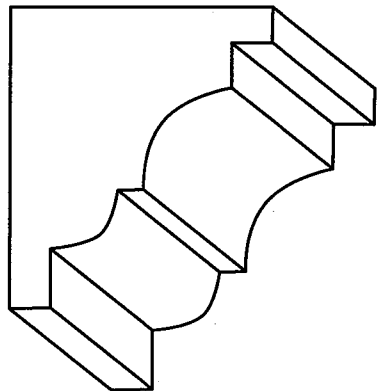

1916

1-5/16 X 1-9/16

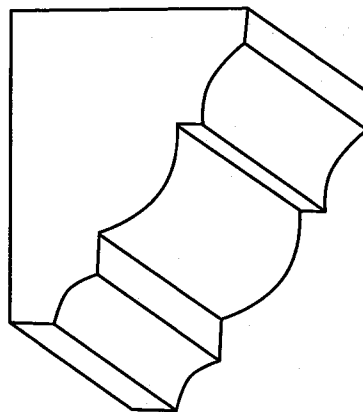

1931

1-1/8 X 1-5/8

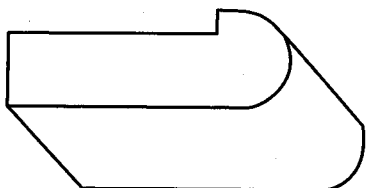

1923

1/2 X 1-7/16

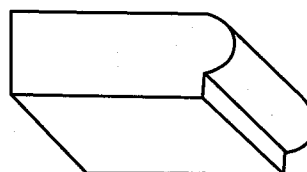

1917

7/16 X 1-1/8



APRONS

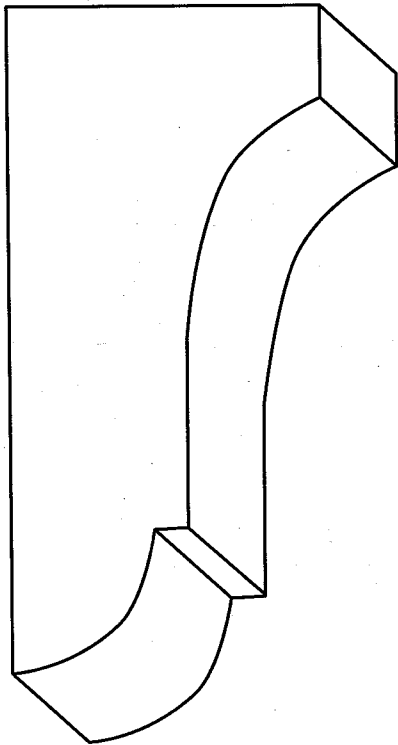

1243

1-5/8 x 3-7/16

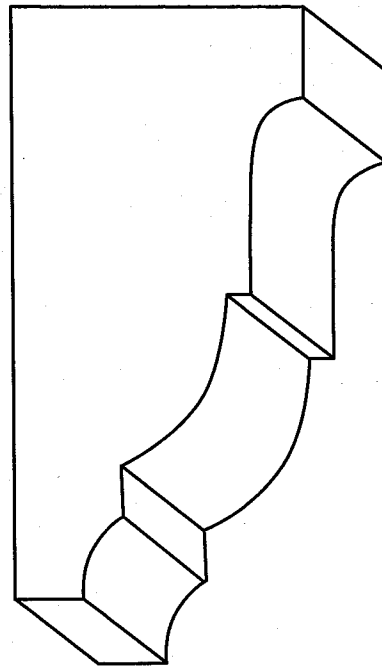

1242

1-1/2 x 3-1/16

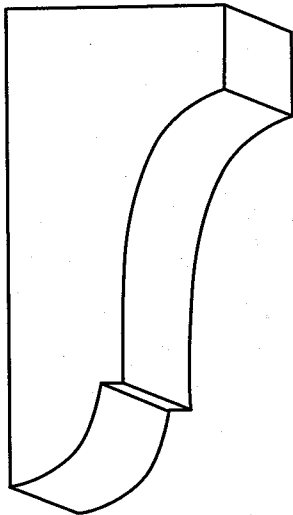

1263

1-1/8 x 2-1/2

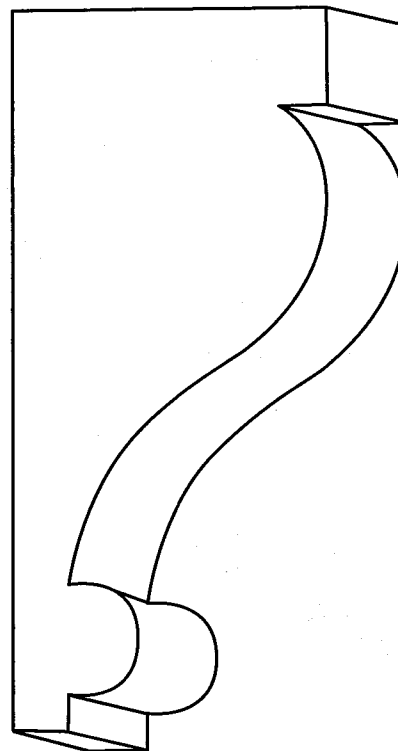

1264

1-5/8 x 3-3/4

LINTEL COMPONENTS

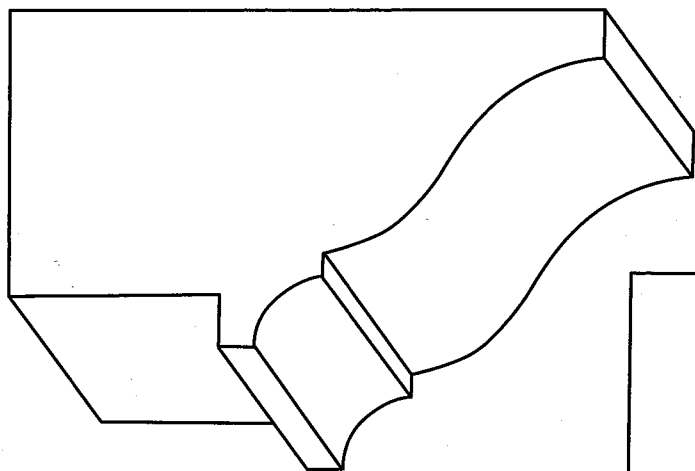

1921

$1-3/4 \times 3-1/16$

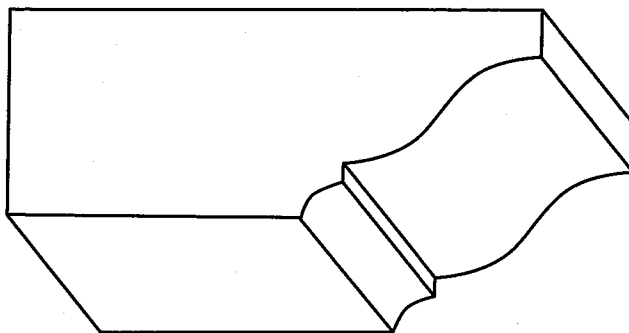

1928

$1-1/8 \times 2-3/4$

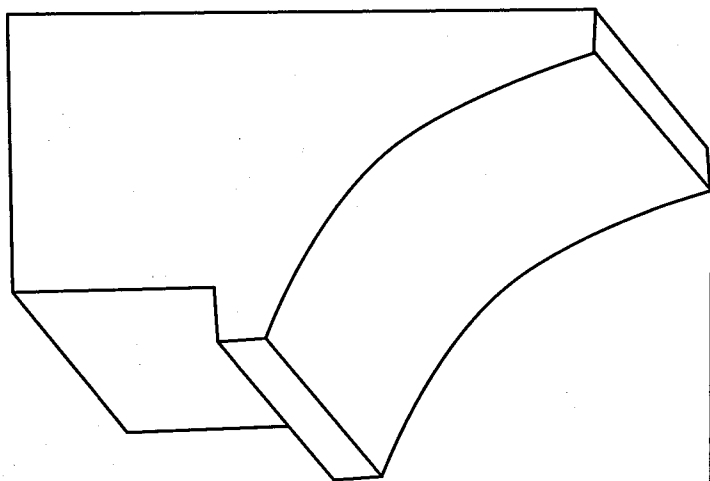

1926

$1-3/4 \times 3-1/16$

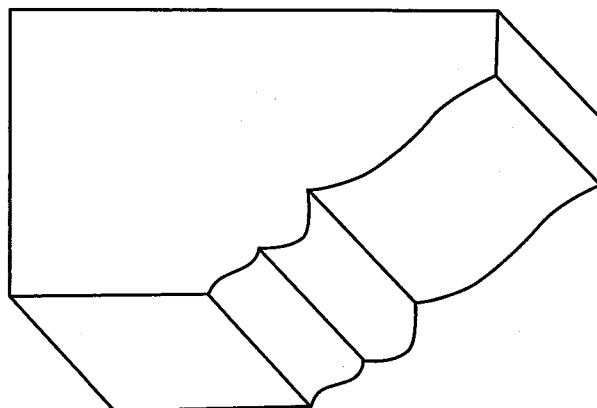

1929

$1-1/2 \times 2-1/2$

BELLY BANDS

66

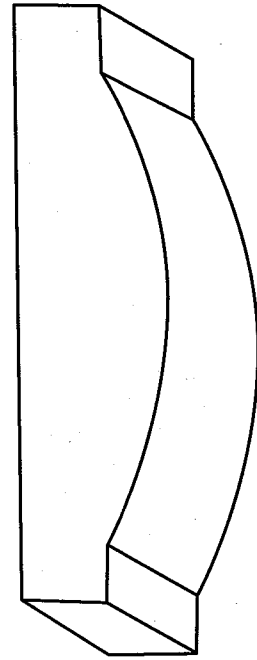
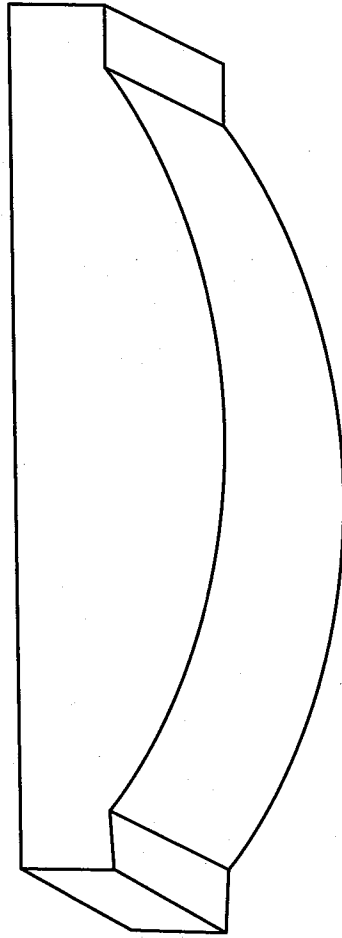
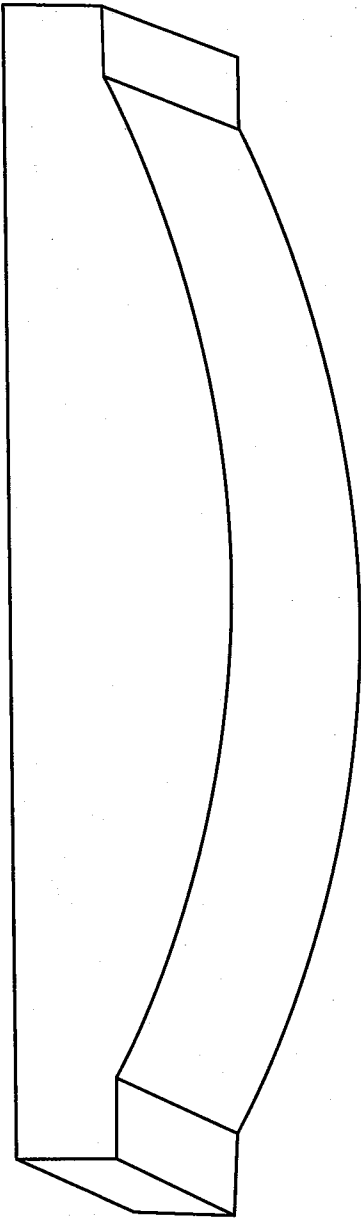

3922

2922

1922

1-1/16 X 6

1-1/16 X 4-1/2

11/16 X 3-1/8

